



National Public Seating

MANUFACTURING EXCELLENCE SINCE 1981

2026 CATALOG



NPS outfits industries across the nation with no-fail equipment used every single day.

DID YOU KNOW ?

NPS operates a nationwide manufacturing and Lightning Ship distribution network, anchored by its primary hub in Clifton, New Jersey, with additional Lightning Ship facilities in Memphis, Tennessee, and Santa Fe Springs, California. These strategically positioned locations enable efficient nationwide distribution through advanced logistics systems and direct access to major transportation networks.

NPS Manufacturing Hub:

📍 Clifton, NJ 07014 (NJ)

Lightning Ship Facilities:

📍 Clifton, NJ 07014 (CL)

📍 Memphis, TN 38106 (TN)

📍 Santa Fe Springs, CA 90670 (CA)



Manufacturing Excellence

Founded in 1981, NPS brings decades of manufacturing expertise supported by a robust global supply chain. Our New Jersey team designs and builds industrial-grade furniture engineered for continuous, real-world use. With in-house design, engineering, and testing, every product bearing the NPS name is built to meet the highest standards of performance, durability, and reliability.

We manufacture with purpose.



— Crafted to Perform

National Public Seating® designs and engineers furniture built for real-world use. With patented innovations, in-house engineering, and certified testing, our products deliver reliable performance in schools, institutions, and high-demand environments nationwide.

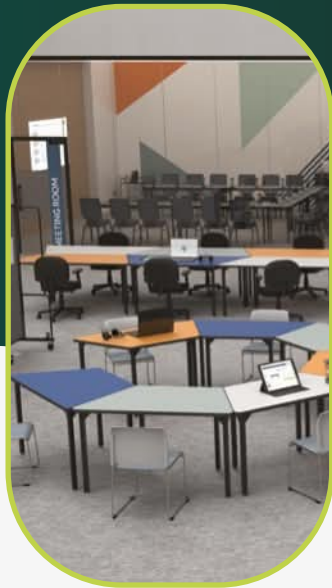

— Solutions for Every Learning Environment

NPS delivers purpose-built furniture engineered to perform across diverse educational spaces, including cafeterias, performing arts rooms, science labs, makerspaces, and modern CTE environments.



— Industry Standards You Trust

Our products are designed, tested, and certified to meet rigorous safety, durability, and performance standards reinforcing our commitment to quality, compliance, and long-term reliability.





Custom designed to reflect your identity. Built to perform.

NPS DESIGN SERVICES

You think it. We create it.

We specialize in designing spaces for institutional spaces, offering a comprehensive service that includes creating 2D and 3D renders to give you a clear visual of how your space will look and how many students will comfortably fit.

HAND SKETCH CONCEPT

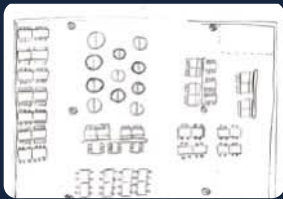

1

Start with Your Idea

NPS 2D DRAWING

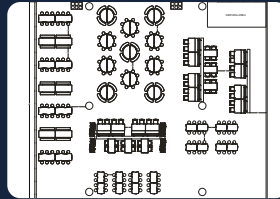

2

We Draft it in 2D

NPS 3D RENDERING



3

We Design it in 3D

The Perfect Way to Show your School's Pride

WE DESIGN

CUSTOM ARTWORK

Matching your logo with artwork that brings your space to life!

We offer the ability to print Custom Designs on our HPL Tabletops. Whether you want to show off your School Logo, Mascot, or simply a Creative Design for Your Space, we can help make it happen.

Available in Leading Design & Specification Platforms



Latest Products

Airflex® Series



New
Platinum
Color!

See more on Pg.18

8700 Series Armrest



See more on Pg.24

New Colors!



8800 Series Chairs & Stools

See more on Pg.25

New Black Color and
New Counter Height Stool!



Bushwick Series



See more on Pg.26

Premium Flex-Back Banquet Chairs



Premium Seating with
Innovative Flex-Back



See more on Pg.29

Adjustable-Height Fold-In-Half Table

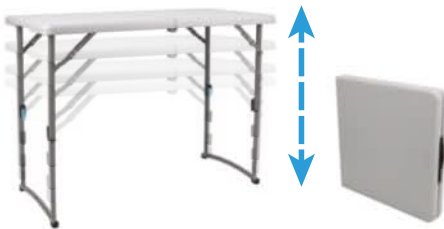

1 TABLE
4 HEIGHTS

See more on Pg.58

Comfort Max Fold-In-Half Tables



Seamless COMFORT,
Spacious Seating!

See more on Pg.60

Elevate your gatherings with
our fold-flat picnic table!



Picnic Tables

4 COLORS
AVAILABLE

See more on Pg.64

Flip It, Nest It, Love It!
The Ultimate Space-Saving
Flipper Tables



Mobile Flipper Tables



See more on Pg.74

Innovative Designer Apron



Heavy Duty Designer Tables



See more on Pg.86

Heavy Duty Activity Tables



25+ Shapes to choose from!

See more on Pg.90

Tool-Free Setup!



Robotics Bumper Kit



See more on Pg.96

Aero-Lift Tables



5 Styles to choose from!

See more on Pg.100

Science Workstations



Empower Your Team's Potential with NPS Science Workstations

See more on Pg.121

Air-Lift Nesting Pneumatic Café Table



Elevate, nest, and style your café with ease

See more on Pg.182

Tuba Rest



Quick & Easy Installation

See more on Pg.191

Redefining Multi-Purpose Storage and Transport

Multi-Purpose Dolly



See more on Pg.215



Innovative New Product Launches Coming Soon

Stay tuned!

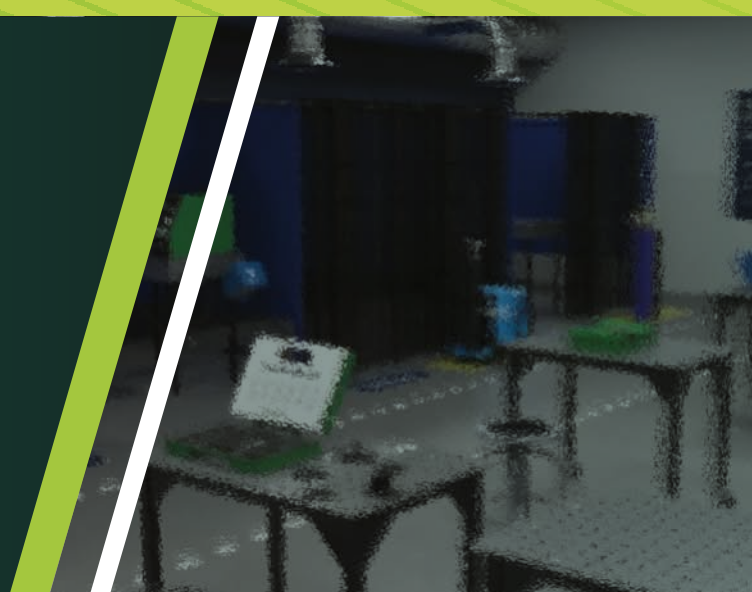

TABLE OF CONTENTS



FOLDING CHAIRS 12



STACK CHAIRS 22



BANQUET CHAIRS 29



MOBILE CHAIRS 35



STOOLS 38



TASK CHAIRS & STOOLS 46



PLASTIC FOLDING TABLES 50



PICNIC TABLES 64



MAX SEATING™ FOLDING TABLES 70



MAX SEATING™ FOLDING BENCHES 73



MOBILE FLIPPER TABLES 74



TITAN TABLES 80



HEAVY-DUTY TABLES 82



ROBOTICS BUMPER KIT 96



AERO-LIFT TABLES 100



MOBILE SCIENCE CABINETS 112



DEMO CABINETS 116



SCIENCE WORKSTATIONS 121



SCIENCE TABLES 124



NEW

TREATMENT TABLES 132



WELDING TABLES 136



WORKSTATIONS 141



MOBILE TABLES 146



CONVERTIBLE BENCH 162



BOOTH SEATING 166



TRASH RECEPTACLE 177



CAFÉ 179



MUSIC 190



CONDUCTOR'S FURNITURE 195



ROOM DIVIDERS 200



STAGES & RISERS 204



DOLLIES 215



LECTERNS 228



SOUND LECTERNS 234



PRESENTATION CARTS 241



CHARGING CARTS 244



PA SYSTEM 245



BASICS BY NPS 248



DESIGN OPTIONS 254



ACTIVITY TABLES SHAPES 266



Quickship Available
For Most Products



State and Regional
Government Contracts



Online Dealer Support

- Price Lists
- Real-Time Stock Check
- Freight Quotes
- Service Portal
- Order Tracking
- Product Configurator



Offering TAA Compliant Products



NEW Online Stage Configurator



Parts under \$25
Ship to End Users with No Charge



Expansive Online Media Center
Image Library - Videos - Brochures



Comprehensive Design and Rendering Services



Our entire product line is MAS Certified Green®.
For more information, visit www.mascertifiedgreen.com



GENERAL PRODUCTS



MOBILE TABLES



OKLAHOMA SOUND®



BASICS BY NPS







FOLDING CHAIRS

Steel Chairs

50, 200, 300,
5200



Upholstered Chairs

1200, 1300, 2200,
2300, 3200



Plastic Chairs

600, 800,
1100, 1400



All-Steel

Standard | Double Brace | Single Hinge | 19-Gauge Frame
50 Series



Premium | Double Brace | Double Hinge | 18-Gauge Frame
200 Series



TAA ✓



Colors



Beige
51



Grey
52



Black
510

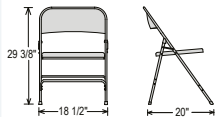

Colors



Beige
201



Grey
202



Brown
203



Char-Blue
204



Black
210



Red
240

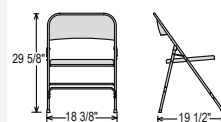

Shared Features

Available Accessories



PGC1

Ganging Device for Models
50 · 200 · 300 · 800 · 1100
· 1200 · 1300 · 2200 · 2300
· 3200 · 5200



MGC

Ganging Device for Models
50 · 200 · 300 · 800 · 1100
· 1200 · 1300 · 2200 · 2300
· 3200



GL

Glides for Models
50 · 200 · 300 · 800 · 1100
· 1200 · 1300 · 2200 · 2300
· 3200 · 5200



VT

V-Tips for Models
50 · 200 · 300 · 800 · 1100 ·
1200 · 1300 · 2200 · 2300 ·
3200 · 5200

**THE
Body
Builder
LINE**

Premium | Triple-Brace | Double Hinge | 18-Gauge Frame
300 Series



Premium All-Steel with Tablet Arm | Double Hinge
5200 Series



TAA ✓

1-2 DAY
LIGHTNING SHIP

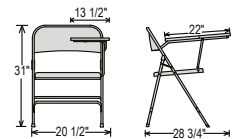

Colors

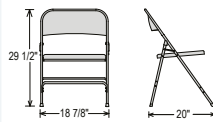

Colors



Grey Tablet Arm
Black Frame
5210R (right handed)
5210L (left handed)

Features



Extended Tablet
Provides Extra
Writing Space



Ultra-Strong Triangular
Gorilla Bracket Adds
Superior Durability

*5200 Cannot Be Transported on Dollies

Shared Features

All Steel Features



Non-Marring
Replaceable Glides That
Match Frame Color



Back Leg
Stability
Plugs



Double
Riveted U
Brace



Curved Ergonomic
Backrest

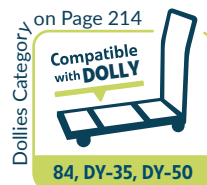

products meet
or exceed applicable
ANSI/BIFMA standards



Vinyl Upholstered

Double Brace | Double Hinge
1200 Series



Triple U Brace | Double Hinge
1300 Series



TAA ✓



Colors



French Beige Vinyl
Beige Frame
1201 / 1301



Warm Grey Vinyl
Grey Frame
1202 / 1302



Dark Midnight Blue Vinyl
Char-Blue Frame
1204 / 1304



Caviar Black Vinyl
Black Frame
1210 / 1310



Honey Brown Vinyl
Beige Frame
1203

Shared Features

Vinyl and Fabric Features



Non-Marring
Replaceable Glides That
Match Frame Color



Back Leg
Stability
Plugs



Double
Riveted U
Brace



Curved Ergonomic
Backrest



Upholstered
Seat and Back



Double Hinge

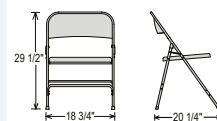

Double Brace | Double Hinge
 2200 Series



Triple U Brace | Double Hinge
 2300 Series



TAA ✓



Colors



Cafe Beige Fabric
 Beige Frame
 2201 / 2301



Greystone Fabric
 Grey Frame
 2202 / 2302



Russet Walnut Fabric
 Brown Frame
 2207



Imperial Blue Fabric
 Char-Blue Frame
 2204 / 2304



Midnight Black Fabric
 Black Frame
 2210 / 2310



Majestic Cabernet Fabric
 Grey Frame
 2208/2308



Imperial Blue Fabric
 Grey Frame
 2205

Shared Features

**THE
 Body
 Builder
 LINE**

See Available
 Accessories on
PAGE 12

Dollies Category, on Page 214
 Compatible with **DOLLY**

 84, DY-35, DY-50

24 HOUR LOAD TEST

 500 lbs
 TESTED BY
BUREAU VERITAS

MAS CERTIFIED GREEN
 For a healthier indoor environment

CAL-117 RATED

BIFMA INTERNATIONAL

ANSI

products meet or exceed applicable ANSI/BIFMA standards

ten year warranty
10

SittigGreen ANSI BIFMA X-2000

Folding Chairs

2" Upholstered Fabric/Vinyl Seat
3200 Series



Blow Molded
600 Series



Fabric Colors



Charcoal Grey Fabric
Black Frame
3212



New Burgundy Fabric
Grey Frame
3218



Regal Blue Fabric
Grey Frame
3215

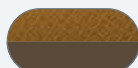

Antique Gold Fabric
Brown Frame
3219

Vinyl Colors



French Beige Vinyl
Beige Frame
3201



Caviar Black Vinyl
Black Frame
3210

Colors

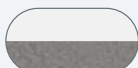

Speckled Grey Plastic
Grey Hammer Tone Frame
602



Blue Plastic
Black Frame
604



Black Plastic
Black Frame
610

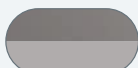

Charcoal Slate Plastic
Silvertone Frame
620



Red Plastic
Black Frame
640

Features



2" Ultra Comfort
Box Seat



High Backrest

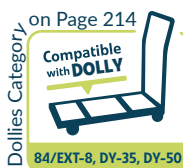
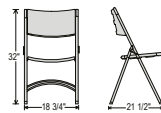
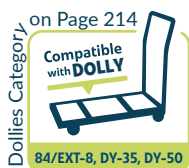
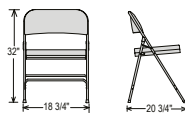

Features



19-Gauge
Steel Frame



Fully Welded
U Brace

**Premium Plastic Lightweight
800 Series**



**SUPER
STACKER**

**1-2 DAY
LIGHTNING SHIP**

**Polyfold Fan Back Triple-Trace
1100 Series**



**SUPER
STACKER**

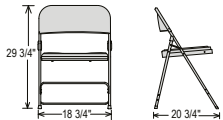

TAA ✓

Dollies Category on Page 214
Compatible with **DOLLY**
84, DY700/800,
DY-35, DY-50

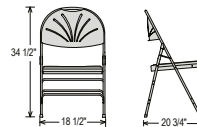

Dollies Category on Page 214
Compatible with **DOLLY**
84/EXT-8, DY35,
DY-50, DY1100

Colors

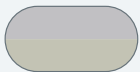

Grey Plastic
Grey Frame
802



Blue Plastic
Grey Frame
805

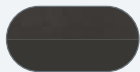

Black Plastic
Black Frame
810



Burgundy Plastic
Black Frame
818

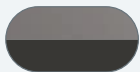

Charcoal Slate Plastic
Black Frame
820



White Plastic
White Frame
821

**CAL-133
RATED**



Colors



Blue Plastic
Grey Frame
1105



Black Plastic
Black Frame
1110



Dark Blue Plastic
Grey Frame
1115

Features



18-Gauge
Steel Frame



Double Riveted
U Brace



7/8" Round
Tubular Frame



Non-Marring
Polypropylene Glides



Double Hinge

**See Available
Accessories on
PAGE 12**



ten year
warranty
10

**BIFMA
INTERNATIONAL
ANSI**

products meet
or exceed applicable
ANSI/BIFMA standards

AirFlex®



COMFORT

Distinct AirFlex® Design
Contours to Each Individual
Making for the Perfect Balance
of Comfort and Strength.



DESIGN

Modern Design
Enhances Any Event.



DURABILITY

Strong 18-Gauge Steel Frame
and Seat Supports Make for
Long Lasting Durability.





Dollies Category on Page 214
 Compatible with **DOLLY**

 84/EXT-8, DY1400

Features



Durable Industrial Grade 3.8MM Polypropylene



Seat Strengthened With Two 11-Gauge Steel Side Supports



Sweat-Free Ventilation



18-Gauge Steel Frame



7/8" Square Leg Tubing for Added Strength



Oversized 18"D Seat



Backrest Secured With Rivets

Colors



Black
1410

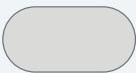

Platinum
1412

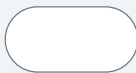

White
1421

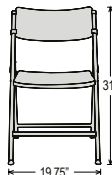

AirFlex® Dimensions
 Overall: 31" H x 19.75" W x 20.25" D
 Folded: 40.25" H x 19.50" W x 2" D
 Seat: 17.25" H x 17" W x 18" D
 Back: 7.5" H x 19.5" W
 Weight: 9.6 lbs.







STACK CHAIRS



Stack Chairs

8100, 8500, 8600, 8700,
8800, Bushwick

Polyshell Stacker
8100 Series



Stacks
10
CHAIRS

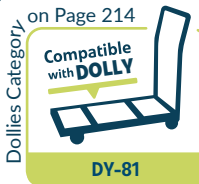

on Page 214
Compatible with **DOLLY**
Dollies Category
DY-81

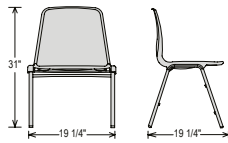

Features



High-Density Injection Molded Poly One-Piece Shell



Frame Shields Protect Against Snags and Pinching



Strong 17-Gauge 7/8" Square Tubing

Colors

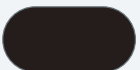

Black
8110



Blue
8125



Available Accessories



TA81L*
Oak Surface
Left Tablet Arm



TA81R*
Oak Surface
Right Tablet Arm



PGC81
Ganging Device

*Chairs can't be stacked with tablet arms attached

Signature Stacker
8600 Series



Stacks
20
CHAIRS

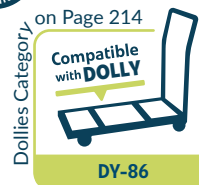

on Page 214
Compatible with **DOLLY**
Dollies Category
DY-86

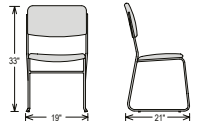

Features



Strong 16-Gauge 1/2" Round Tubing



Contoured Seat and Back for Enhanced Comfort



Non-Marring Floor Glides

Colors



Ebony Black
8660



Classic Grey
8652

Accessories



MGC86
Ganging Device



products meet or exceed applicable ANSI/BIFMA standards



Black Frame / Black Fabric Also Available as Custom Order for 8600

Hi Tech Ultra Compact Stacker
8500 Series



Features



Molded Seat and Back Provide Comfort and Allow for Easy Interstacking



Protective Rounded Polycarbonate Floor Glides With Custom Clamping Device



Reinforced Underseat Ribbing for Added Strength



Chrome-Plated 11mm Steel Rod Frame

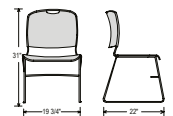

Colors



Wine
8508



Black
8510



Gunmetal Grey
8502



Navy Blue
8505

Available Accessories



TA85L*
Black Left
Tablet Arm



TA85R*
Black Right
Tablet Arm



BR85
Book Basket



PGC85
Ganging Device

*Chairs can't be stacked with tablet arms attached



Dollies Category



on Page 214



products meet or exceed applicable ANSI/BIFMA standards



STACK CHAIRS | 8700 SERIES
Padded Cafetorium Chair

VINYL
 SEAT



8700 Add-On Armrest
Compatible with all 8700 Heights
 Optional Armrest with black frame and black plastic arm



18" SEAT HEIGHT

See Page 265 for Custom Color Options

Standard Colors

- 8704-10-04
Blue Poly and Blue Vinyl
Black Frame
- 8710-11-10
Black Poly and Black Vinyl
Chrome Frame
- 8742-12-02
Grey Poly and Blue Vinyl
Silver Frame

Add code 'A' to the end of the model number to add Armrests



24" SEAT HEIGHT

See Page 265 for Custom Color Options

Standard Colors

- 8710C-11-10
Black Poly and Black Vinyl
Chrome Frame

Add code 'A' to the end of the model number to add Armrests



30" SEAT HEIGHT

See Page 265 for Custom Color Options

Standard Colors

- 8710B-11-10
Black Poly and Black Vinyl
Chrome Frame

Add code 'A' to the end of the model number to add Armrests



Chair Features 8700/8800



"Rod In Tube" Design



Glides Function as Built-in Gangers for Multi Chair Setup



Polypropylene Plastic Back Design Provides Ergonomic Support



Glides Are Made of TPU For Sensitive Floors



on Page 214
 Compatible with **DOLLY**
 DY-87
 Stacks **35** CHAIRS

30 3/4"
 20"
 20"

POLY

SEAT



18" SEAT HEIGHT

See Page 265 for Custom Color Options



24" SEAT HEIGHT

See Page 265 for Custom Color Options



30" SEAT HEIGHT

See Page 265 for Custom Color Options

Standard Colors

- Blue Poly Chrome Frame 8804-11-04
- Black Poly Chrome Frame 8810-11-10
- Charcoal Poly Chrome Frame 8820-11-20
- White Poly Chrome Frame 8801-11-01
- Red Poly Chrome Frame 8817-11-17

Standard Colors

- Blue Poly Chrome Frame 8804C-11-04
- Black Poly Chrome Frame 8810C-11-10
- Charcoal Poly Chrome Frame 8820C-11-20

Standard Colors

- Blue Poly Chrome Frame 8804B-11-04
- Black Poly Chrome Frame 8810B-11-10
- Charcoal Poly Chrome Frame 8820B-11-20



Bar Stool Features 8700/8800

- Plastic Stacking Bumpers
- Welded Footrest
- 7/8" Leg Tubing
- Floor-Safe Non-Marring Glides

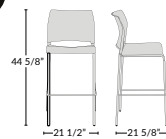

on Page 214
Compatible with **DOLLY**
Dollies Category
DY-87B

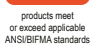

Bushwick Bentwood Chairs & Stools



*Stackable, stylish, and built to thrive:
The Bushwick series, the perfect
cafeteria seating solution*



Features



Heavy-Duty Bumpers
for Safe and Secure
Stackability



Modern Handle for
Easy Movement
and Storage



4 Fully Welded
12-Gauge Under-Seat
Support Brackets



1/2" Thick 8-Layer
Bent Plywood Seat
With HPL Finish



Legs Designed
For Easy Stackability



7/8" 16-Gauge
Chromed Steel Tubing



Designer Contoured
Waterfall Edge



Durable Non-Marring
Polypropylene Glides

Barstool



Heavy-Duty Welded Footing
for Added Comfort and Stability



Bentwood Chair



18" SEAT HEIGHT

Bentwood Counter Height Stool



24" SEAT HEIGHT

Bentwood Bar Height Stool



30" SEAT HEIGHT

Colors

Espresso (21) Natural (22) Black (23)

on Page 214
 Compatible with **DOLLY**
 DY81, DY-9000
 For Chairs

on Page 214
 Compatible with **DOLLY**
 DY81
 For Stools



products meet or exceed applicable ANSI/BIFMA standards

Model	Total Width	Total Depth	Total Height	Seat Height	Footring Height	Back Width	Back Height
Chair	21 ½"	23¼"	33 7/8"	18"	N/A	15 ¾"	18"
Counter Stool	21 ½"	22 ¼"	40 ¼"	24"	7 ½"	15 ¾"	18"
Bar Stool	21 ½"	22 ¼"	46 ½"	30"	13 ½"	15 ¾"	18"

Model Number Configuration

Model Number Color

BC C 21

Chair 18" (C) Counter 24" (M) Bar 30" (S)

BANQUET CHAIRS



BANQUET CHAIRS | 9600 SERIES
Premium Flex-Back Banquet Chairs



NEW!
**Premium Seating with
Innovative Flex-Back**



Premium Flex-Back Banquet Chairs



Enhanced Fabric Durability
Reinforced fabric with double stitching to prevent tearing and eliminate exposed areas to avoid openings.



INNOVATIVE FLEXIBILITY

The flex-back mechanism enables the chair's backrest to move, providing optimal comfort during long periods of sitting.



DURABLE CONSTRUCTION

Full-width back supports ensure longevity in demanding environments with heavy use, making them a lasting investment.



ULTIMATE COMFORT

Experience ultimate comfort with our plush 3-inch thick PU foam seat cushion.

BANQUET CHAIRS | 9600 SERIES

Premium Flex-Back Banquet Chairs



Available Accessories



PGC81
Ganging
Device



GL9600SO
9600 Slip
Over Glides



Dollies Category

on Page 214

Compatible
with **DOLLY**

DY81, DY-9000

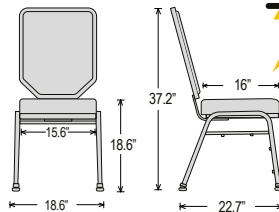

products meet
or exceed applicable
ANSI/BIFMA standards



Rated for a 300 lbs weight capacity, this chair exceeds 100,000 back flex cycles at 75 lbs in UL testing. This rigorous test replicates the force of a 300 lbs user, demonstrating exceptional strength and durability.

Features



Seat Cushion Made with Plush 3" Thick PU Molded Foam

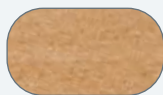

MDF Core Seat and Back



Stacking Bars and Plastic Stack Bumpers Ensure Secure Stacking



Tested by UL to Exceed 100,000 Back Flex Cycles



Premium Double Back Conceals Steel Full-width back supports



18 Gauge Steel Frame with Self-Leveling Glides

Fabric Colors

CULP Premium Fabrics



Morticia Lithium
82



Morticia Blue Lagoon
84



Morticia Taupe
88



Morticia Onyx
90

CUSTOM COLOR OPTIONS AVAILABLE!
We can do any CULP Fabric/Vinyl
MOQ, Upcharge, and Extended Lead Times Apply

Frame Color



Black Gloss
BG



Model Number Configuration

Prefix | Frame Color
96 84 - BG
Fabric/Vinyl Color

Banquet Chairs



Banquet Chairs

Dome Back 9200 Series



Silhouette Back 9300 Series



Stacks
10
CHAIRS

on Page 202

Compatible
with **DOLLY**

DY81, DY-9000



Standard Colors



See Page 264 for Custom Color Options



9254-SV
Midnight Blue Fabric
Silver Vein Frame



9201-M
French Beige Vinyl
Mocha Frame



9254-BT
Midnight Blue Fabric
Black Sandtex Frame



9204-SV
Midnight Blue Vinyl
Silver Vein Frame



9260-SV
Ebony Black Fabric
Silver Vein Frame



9204-BT
Midnight Blue Vinyl
Black Sandtex Frame



9260-BT
Ebony Black Fabric
Black Sandtex Frame



9210-SV
Panther Black Vinyl
Silver Vein Frame



9210-BT
Panther Black Vinyl
Black Sandtex Frame

Standard Colors



See Page 264 for Custom Color Options



9304-SV
Midnight Blue Vinyl
Silver Vein Frame



9362-BT
Natural Greystone Fabric
Black Sandtex Frame



9310-BT
Panther Black Vinyl
Black Sandtex Frame



9364-SV
Diamond Navy Fabric
Silver Vein Frame



9354-SV
Midnight Blue Fabric
Silver Vein Frame



9374-BT
Natural Blue Fabric
Black Sandtex Frame



9360-BT
Ebony Black Fabric
Black Sandtex Frame



9378-BT
Natural Taupe Fabric
Black Sandtex Frame

Features



2" 1.8lb. High-Density Grade A Foam Waterfall Seat

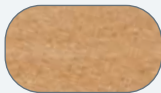

MDF Core Seat and Back



Stacking Bars And 12 Plastic Stack Bumpers Ensure Secure Stacking



7/8" Square 18 Gauge Tubing With Non-Marring Glides 5/8" Underseat H Braces

9200



Back Rests On 4 Tabs For Extra Durability

9300



Premium Double Back Conceals 4 Steel Backrest Tabs

CAL-117
RATED

ten year
warranty
10

BIFMA
INTERNATIONAL

ANSI

products meet
or exceed applicable
ANSI/BIFMA standards

MADE
CERTIFIED
GREEN
For a healthier indoor environment

MOBILE CHAIRS



MOBILE CHAIRS | COGO SERIES
CoGo Mobile Tablet Chair
 Modern chair for today's collaborative learning!



DESIGN

Ergonomically Designed For All-Day Seating Support; Contemporary Design Enhances the Modern Classroom.



MOBILITY

Allows Students to Move to Different Learning Areas With Ease.



DURABILITY

16 Gauge Steel and Twin 2 Inch Casters for Long-Lasting Classroom Use.



products meet or exceed applicable ANSI/BIFMA standards



Features



Strong Twin Wheeled 2" Casters



Fiberglass-Reinforced Polypropylene



Tablet Can Be Installed on the Right or Left Side

Seat Colors



Black
COGO-10



Blue
COGO-04

Available Accessory



GLCOGO
Set of Four Glides



STOOLS



Stools
6200, 6300,
6400, 6500



**Designer
Stools**
6600, 6800,
Titan



**Task Chairs
and Stools**
6700, CTC



Heavy-Duty Masonite Seat Stools

Features



8 Rivets on Seat To Ensure Longevity



Heavy-Duty 18-Gauge 7/8" Steel Tubing



Industrial Grade Glides



Four Weld Points at Each Leg for Extreme Durability



Add-on Backrest Adjusts 2" Up/Down and 2" Forward/Back



Add-on Chromed Adjustable Height Inserts Adjust to Nine Heights



STANDARD



BACKREST



ADJUSTABLE HEIGHT



ADJUSTABLE HEIGHT & BACKREST



Model #	Seat Height
6218	17"
6224	24"
6230	30"
6218H	19-26"
6224H	25-32"
6230H	31-38"

Model Number Configuration



Frame Colors

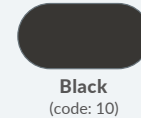

Seat Color



Add-on Codes

Backrest	B
Adjustable Height	H
Adjustable Height and Backrest	HB

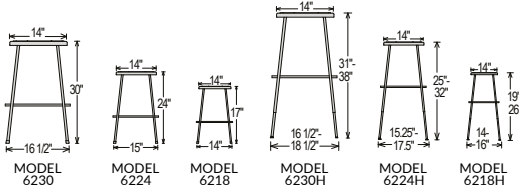

Heavy-Duty Masonite Seat Stools

Features



16 Rivets on Seat To Ensure Longevity



Four Weld Points at Each Leg for Extreme Durability



Industrial Grade Glides



Heavy-Duty 18-Gauge 7/8" Steel Tubing



Add-on Backrest Adjusts 2" Up/Down and 2" Forward/Back



Add-on Chromed Adjustable Height Inserts Adjust to Nine Heights



STANDARD



BACKREST



ADJUSTABLE HEIGHT



ADJUSTABLE HEIGHT & BACKREST



Model # Seat Height

6318	17"
6324	24"
6330	30"
6318H	19-26"
6324H	25-32"
6330H	31-38"

Model Number Configuration

Model Number Add-on Code (if applicable)

6318H

Frame Colors



Grey

Seat Color



Masonite

Add-on Codes

Backrest	B
Adjustable Height	H
Adjustable Height and Backrest	HB

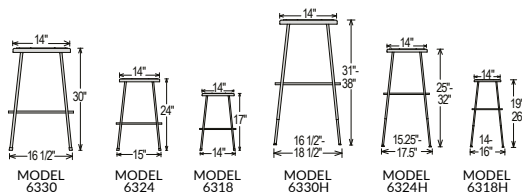

TAA
OPTIONS AVAILABLE



products meet or exceed applicable ANSI/BIFMA standards



Heavy-Duty Padded Stools

Features



Padded Vinyl Seat



Heavy-Duty 18-Gauge
7/8" Steel Tubing



Industrial Grade
Glides



Four Weld Points at
Each Leg for Extreme
Durability



Add-on Backrest
Adjusts 2" Up/Down
and 2" Forward/Back



Add-on Chromed
Adjustable Height Inserts
Adjust to Nine Heights



STANDARD



BACKREST



ADJUSTABLE HEIGHT



ADJUSTABLE HEIGHT & BACKREST



Model # Seat Height

6418	18"
6424	24"
6430	30"
6418H	19-27"
6424H	25-33"
6430H	32-39"

Model Number Configuration



Stool Colors



Grey Vinyl
Grey Frame
(no code)



Black Vinyl
Black Frame
(code: 10)



Add-on Codes

Backrest	B
Adjustable Height	H
Adjustable Height and Backrest	HB

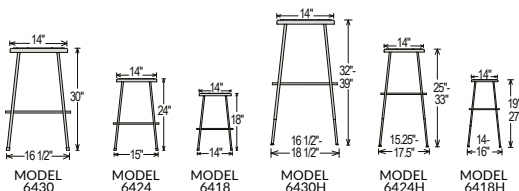

products meet
or exceed applicable
ANSI/BIFMA standards

STOOLS | 6500 SERIES
Heavy-Duty Padded Stools

Features



Height Adjustable from 24"-30"



1/2" Vinyl Padded Riveted Thru the Steel Seat Pan



7/8" O.D. 16-Gauge Steel Tubing



Foot Rings, 5/8" O.D. Welded to Each Leg



Add-on Backrest Adjusts 2" Up/Down and 2" Forward/Back

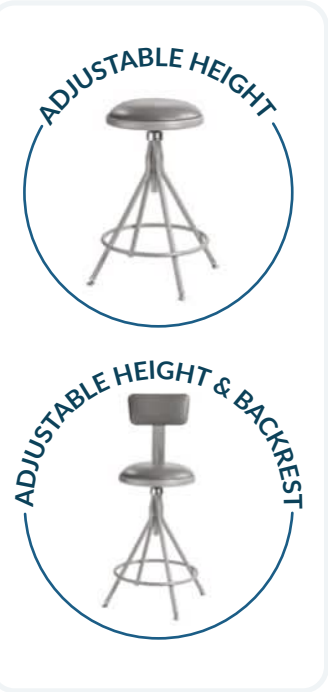

Stool Color



Grey

Model #	Height	Description
6524HB	24-30"	Stool with Backrest
6524H	24-30"	Stool without Backrest

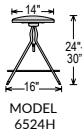
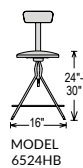

The Contemporary Designer Stool

Steel Seat

Metallic grey or black base and heavyduty steel seatpan with an aesthetically pleasing polypropylene plastic surface available in an array of colors.

Metal Seat Height Adjustable from 18" – 24"



Seat Colors

All seats are on grey steel

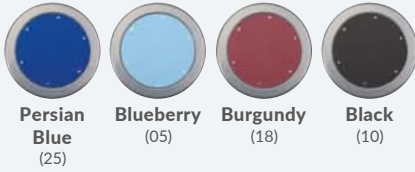

Wooden Seat

Metallic grey or black base and a robust 1.2" thick Solid Oak wood seat with a clear lacquer finishing.

Wood Seat Height Adjustable from 19" – 25"



Seat Color



Features



360° Turning Capability



Non-Marring Glides

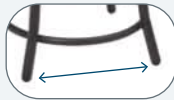

20" Cross Leg Distance



Metal Center Sleeve Conceals Adjustable Height Pole



Seat Adjustable Using the Swivel Mechanism



Built in 4" Height Footrest With a 15" Diameter

Frame Colors



Grey
02



Black
10



Model Number Configuration

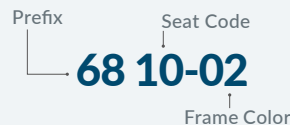

products meet or exceed applicable ANSI/BIFMA standards



Model Number Configuration

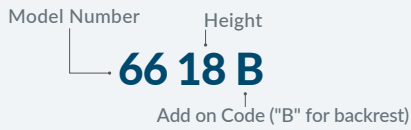

Model # | Seat Height

6618	18"
6622	22"
6624	24"



products meet or exceed applicable ANSI/BIFMA standards

Features



Additional Weld on Bottom for Added Strength



Riveted Glides For Added Stability



Conveniently Stackable



Optional Fan-Back For Extra Comfort



14 Gauge Eye-Tubular Steel Frame



Nests on Tabletops For Easy Cleanup and Storage!



Ergonomic Blow Molded Seat Provides Maximum Comfort



Embedded Thermoplastic Polyurethane TPU Glides Provide Quiet and Smooth Gliding On All Floor Types



Oversized Contact Area For Extreme Stability



Rear Brace For Added Strength



Built in 4" Height Footrest With a 15" Diameter

6622/6624



TITAN STOOL



Comfort Task Chair and Stool

Comfort Task Stool



360°

Comfort Task Chair



360°

TAA ✓

1-2 DAY
LIGHTNING SHIP

Fabric tested to
EXCEED 70,000
double rubs

WEIGHT CAPACITY
300
lbs

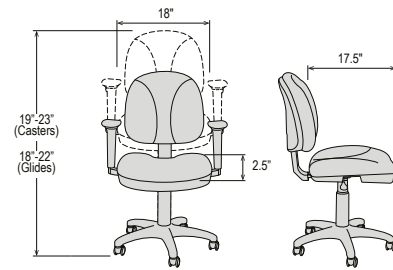
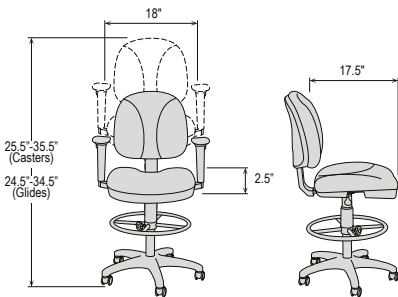

Features



Plush Padded Seat
And Back



Includes Five 2"
Industrial Grade Casters
and Mushroom Glides



Plastic Reinforced
Backrest and Seat

Add-On



Optional Armrest With
11 Adjustable Heights,
Including Lowest Position
(½ Inch Increments)

Model # Description

CTC	18"-22" (Glides) 19"-23" (Casters) Comfort Task Chair
CTC-A	18"-22" (Glides) 19"-23" (Casters) Comfort Task Chair with Adjustable Height Armrests
CTS	24.5"-34.5" (Glides) 25.5"-35.5" (Casters) Comfort Task Stool
CTS-A	24.5"-34.5" (Glides) 25.5"-35.5" (Casters) Comfort Task Stool with Adjustable Height Armrests

CAL-117
RATED

MADE
CERTIFIED
GREEN
For a healthier indoor environment

ten year
warranty
10

BIFMA
INTERNATIONAL
ANSI

products meet
or exceed applicable
ANSI/BIFMA standards

Polyurethane Task Chair



Polyurethane Task Stool



**1-2 DAY
 LIGHTNING SHIP**



Features



Convenient Backrest Handhold for Maneuverability



Includes Five 2" Industrial Grade Casters and Mushroom Glides



Backrest Tilt

Add-On



Optional Armrest with 11 Adjustable Heights, Including Lowest at 1/2 Inch Increments

Model #	Description
6716HB	16"-21" Polyurethane Chair (desk height)
6722HB	22"-32" Polyurethane Stool
6716HB-A	16"-21" Polyurethane Chair (desk height) with Adjustable Height Armrests
6722HB-A	22"-32" Polyurethane Stool with Adjustable Height Armrests



products meet or exceed applicable ANSI/BIFMA standards







PLASTIC FOLDING TABLES

Industrial Grade Plastic Folding Tables

1800, 2400,
3000, 3600, BTA, BTR,
BMFIH, BPFT, BFHT-2448A



Comfort Max Fold-In-Half Tables

CMFIH



Picnic Tables

BMPT



Seminar Tables



The ideal choice for your seminar and training needs—indoor, outdoor, or any application requiring affordable, lightweight, weather-resistant, and highly durable tables.



on Page 214

Compatible with **DOLLY**

DY-MPD, TAD, DYMU

THREE SIZES AVAILABLE



Model #	Size
BT1860	18"x60"
BT1872	18"x72"
BT1896	18"x96"

Colors

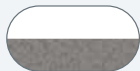

Speckled Grey Plastic
Grey Hammer Tone
Frame

Features



Unique Spring-Loaded Lock For Complete Stability

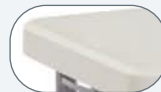

2" Thick UV Protected Tabletop

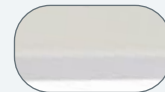

Textured Tabletop Surface Smooth Enough For Writing



Industrial Grade Framing System



16-Gauge Cantilever Comfort Legs

60" 72" 96"

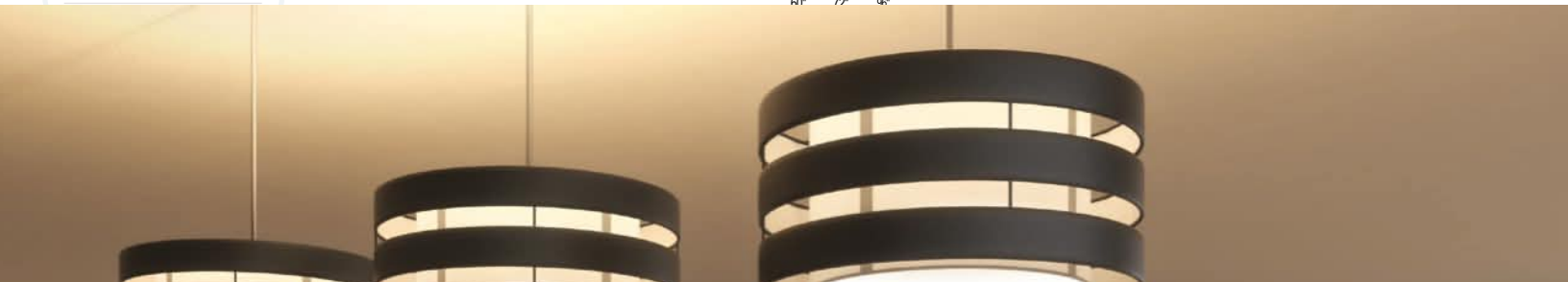

Blow Molded Folding Tables

on Page 214

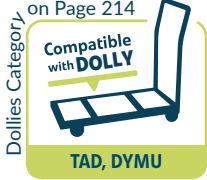

Features



17-Gauge Framing System



Built In Handle For Easy Lifting



Extra Stable Gravity Lock

Colors



Speckled Grey Plastic
Grey Hammer Tone Frame

Model Number
BT2448

can withstand heat up to **212°**

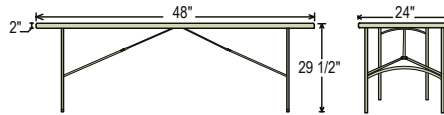

evenly distributed



ANSI

products meet or exceed applicable ANSI/BIFMA standards



Features



19-Gauge Framing System



Attractive Arched Tube Leg Connectors For Added Strength

can withstand heat up to **212°**

Model Number
BT3636

Colors



Speckled Grey Plastic
Grey Hammer Tone Frame

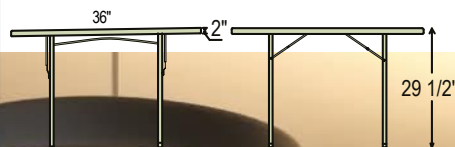

evenly distributed



ANSI

products meet or exceed applicable ANSI/BIFMA standards

PLASTIC FOLDING TABLES | BT3000 SERIE
Blow Molding Folding Tables



on Page 214
 Dollies Category
 Compatible with DOLLY
 TAD, DYMU, DY3072/DY3096



BT3072-20



Features



18-Gauge Legs



17-Gauge Framing System



Heavy Duty Wishbone Leg Structure



Extra Stable Gravity Lock

Colors



BT3000 series
 Speckled Grey Plastic
 Grey Hammer Tone Frame



BT3072-20 series
 Charcoal Slate Plastic
 Silvertone Frame (30"x72" only)

Model #	Size
BT3060	30"x60"
BT3072*	30"x72"
BT3096	30"x96"

*add -20 for Charcoal Slate

THREE SIZES AVAILABLE

can withstand heat up to **212°**



BT3060/BT3072



evenly distributed

BT3096



evenly distributed



products meet or exceed applicable ANSI/BIFMA standards

Brighten up your room to create a complete portable Furniture Suite, with these attractive, affordable, Quick Ship Tables!



Features



Lightweight 37lbs For Easy Setup and Transport



Adjustable Height From 22-28.5"

Colors



BTA-3072-40
Red Plastic
Black Frame



BTA-3072-04
Blue Plastic
Black Frame

on Page 214
Compatible with **DOLLY**
Dollies Category
TAD, DYMU, DY3072/DY3096

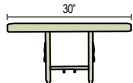
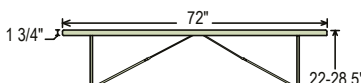

Round Folding Tables



The perfect solution for your banquet & cafeteria use – indoor, outdoor, or any other application that calls for affordable, lightweight, weather resistant and highly durable folding tables.



Dollies Category on Page 214
Compatible with **DOLLY**
DY-60R, DY-71R, DYMU

1-2 DAY LIGHTNING SHIP

can withstand heat up to **212°**

Features

All Round Tables		BT48R/BT71R		BT60R	
	Gravity Lock		2" Thick UV Protected Tabletop		19-Gauge Framing System
	700 LBS Weight Capacity		17-Gauge Framing System		1000 LBS Weight Capacity

Colors

Speckled Grey Plastic
Grey Hammer Tone Frame

Model #	Size
BT48R	48"
BT60R	60"
BT71R	71"

THREE SIZES AVAILABLE



ten year warranty **10**



PLASTIC FOLDING TABLES | BMFIH SERIES
Fold-In-Half Tables



Features



Automatic Locking Device for Safe Setup



1.5" High-Density Polyethylene (HDPE) Top



Gravity Lock



First of Its Kind! Rounded Ends and Oblique Edges.



No Cross Bar Allows For Additional Seating At The End Of The Table



Powder-Coated 19-Gauge Steel Frame



Convenient Carrying Handle for Easy Transport



Lightweight 37lbs for Easy Setup and Transport

Colors



Speckled Grey Plastic
 Grey Hammer Tone Frame



Open dimensions:
 71.8"L x 30"W x 29.5"H
 Folded dimensions:
 36"L x 30"W x 3.75"D

Model Number
BMFIH3072

can withstand heat up to
212°

1-2 DAY LIGHTNING SHIP



evenly distributed



products meet or exceed applicable ANSIBIFMA standards



Roll In



Flip



Store



Features



Frame and Legs Are Made With Industrial Grade Powdercoated Steel



Perforated Steel Modesty Panel With a Built-in Cable Channel To Conceal Wires



Four 2" Casters (Two Locking) Enable Tables to Roll With Ease



Lightweight 37lbs for Easy Setup and Transport



Two Grommet Holes for Wire Management



Tables Nest for Easy Storage



Use Lever to Collapse Tables for Easy Storage



17-Gauge Steel Frame



evenly distributed



products meet or exceed applicable ANSI/BIFMA standards



Adjustable-Height Fold-In-Half Table



22" Height | **CHILDREN'S ACTIVITIES**



24" Height | **HOBBY TABLE**



1 TABLE
4 HEIGHTS



Fold In Half



*Discover the Perfect
Adjustable-Height Fold-in-Half Table:
Your ultimate companion for events,
gatherings, and versatile spaces.*

PLASTIC FOLDING TABLES | BFHT -2448A
Adjustable-Height Fold-In-Half Table

29" Height | OFFICE WORKSPACE

35" Height | PARTY AND EVENTS



Simplify Your Space: Unfold, Configure, Store, Repeat!

Unfold

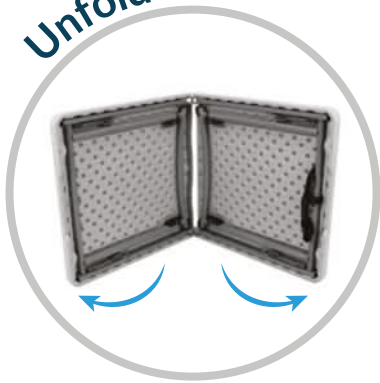

Use



Store



Features



1 3/4" Thick Industrial Grade Blow Molded Tabletop



Fold in Half for Easy Storage



Simple-Click Height Adjustment Mechanism



Gravity Lock with Clicking Mechanism for Added Stability



Powder-Coated 18-Gauge Framing System



Convenient Carrying Handle For Easy Transport



Heavy Duty Glides Provide a Secure Footing

can withstand heat up to **212°**

Colors



Speckled Grey Top Grey Frame

Model Number **BFHT-2448A**



products meet or exceed applicable ANSI/BIFMA standards

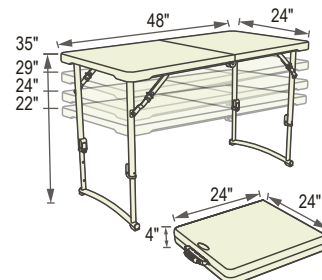

PLASTIC FOLDING TABLES | CMFIH SERIES
Comfort Max Fold-In-Half Tables

*Transform Any Space, Anytime:
Comfortable, Foldable, and Ready
to Impress!*

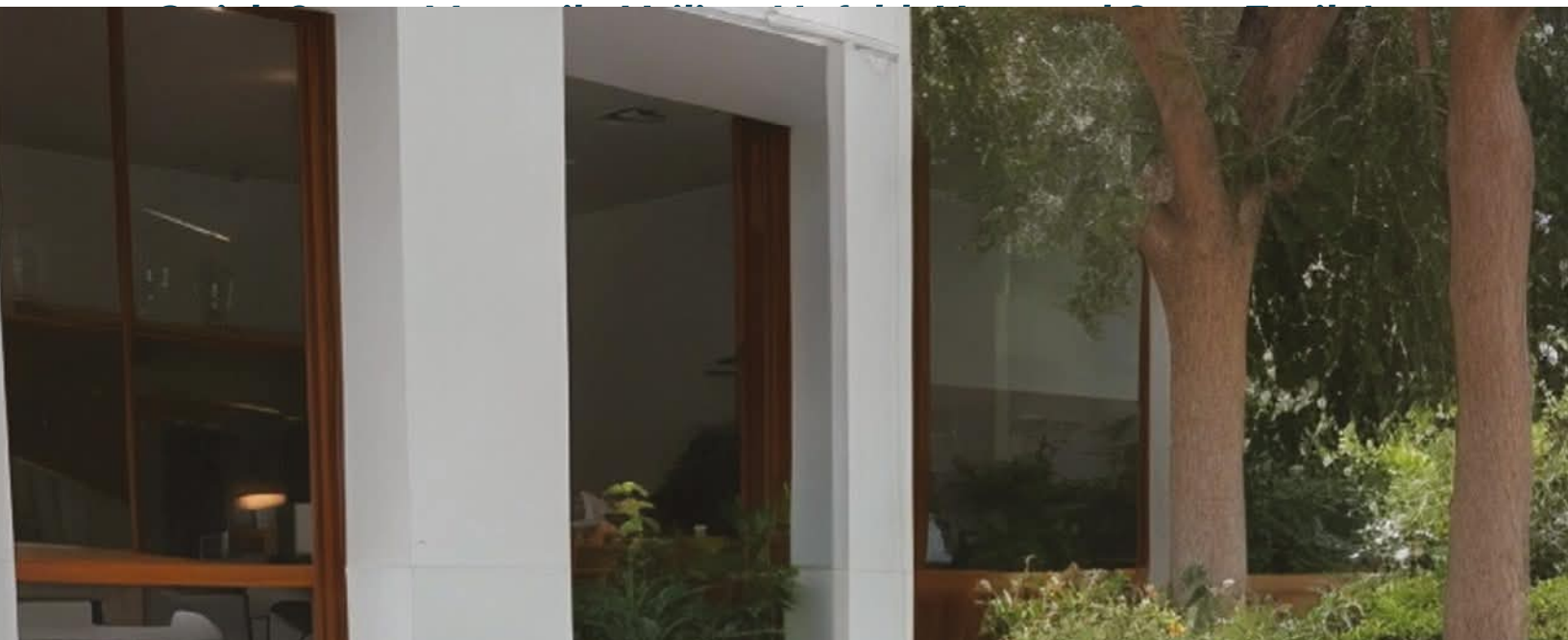

PLASTIC FOLDING TABLES | CMFIH SERIES
Comfort Max Fold-In-Half Tables

Featuring Auto-Locking Technology



Seamless Comfort, Spacious Seating!



Rectangle and Round Tables Available!

Shared Features

Instant Setup: No assembly required!



Stain Resistant
and Easy to Clean



Lightweight
Design



Built-In Carry Handle



Durable Polyethylene
Tabletop with
Beveled Edges



Safety Gravity Locks
Ensure Table Legs are
Secure During Use



AUTO-LOCKING

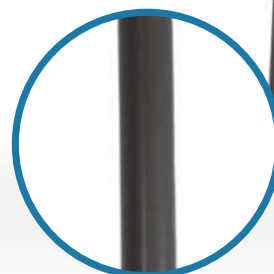

Constructed with
Industrial Strength Steel

PLASTIC FOLDING TABLES | CMFIH SERIES
Round Comfort Max Fold-In-Half Tables



Easy Transportation & Storage!



Round Tables Features



2" Thick Industrial Grade Blow Molded Tabletop

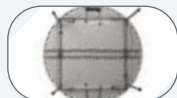

Powder-Coated 19-Gauge Framing System



18-Gauge Legs with Non-Slip Glides

Colors



Speckled Grey Top
 Grey Frame

can withstand heat up to **212°**



evenly distributed

Model # **Size**

CMFIH48R 48"
 CMFIH60R 60"

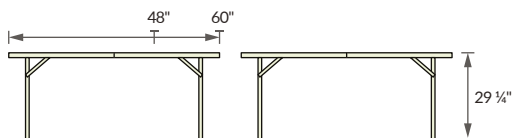

products meet or exceed applicable ANSI/BIFMA standards

PLASTIC FOLDING TABLES | CMFIH SERIES
Rectangle Comfort Max Fold-In-Half Tables



Easy Transportation & Storage!



Rectangular Tables Features



1.75" Thick Industrial Grade Blow Molded Tabletop

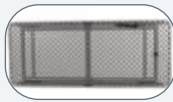

Powder-Coated 18-Gauge Framing System



18-Gauge Legs with Non-Slip Glides

Colors



Speckled Grey Top Grey Frame

can withstand heat up to **212°**



evenly distributed

Model #	Size
CMFIH3060	30" x 60"
CMFIH3072	30" x 72"
CMFIH3096	30" x 96"

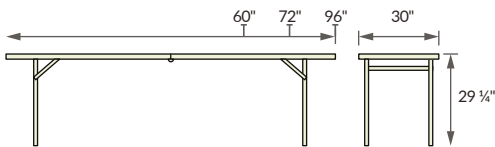

Picnic Tables



Elevate your picnics with our fold-flat table! Lightweight, durable, and colorful. The perfect outdoor/indoor companion

Picnic Tables

...

Picnic Tables



4 COLORS
AVAILABLE

Picnic Tables

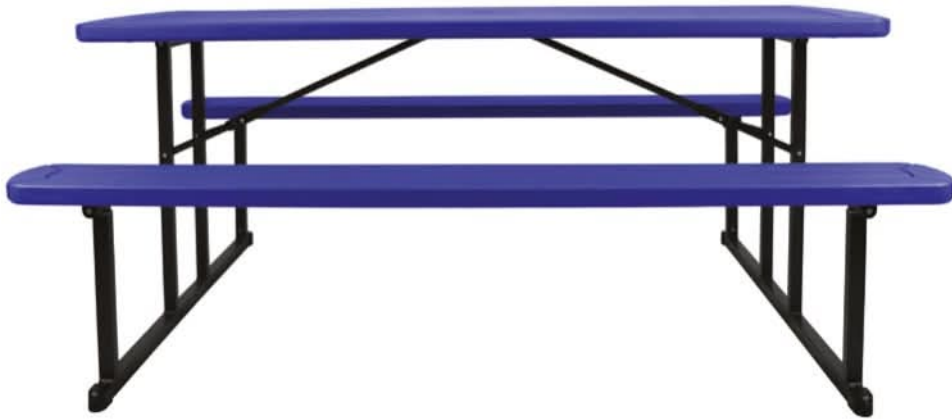

Compactly folds to just 3" high, saving valuable storage space!



Instant Picnic Magic: Set Up, Enjoy, Store with Ease!

Open

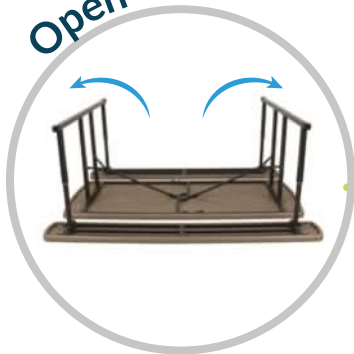

Use



Store





Seats Up to 8 People Comfortably



Stain Resistant and Easy to Clean

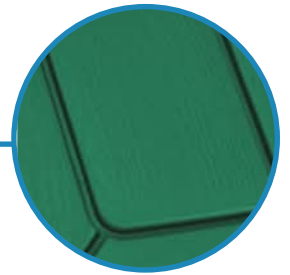

Blow Molded Plastic with Wood Grain Texture



Industrial Grade 18-Gauge Powdercoated Weather Resistant Steel Frame that is Durable and Protects Against Rusting and Corrosion



Tamper-Proof Bench Connection. Locked in Place for Good!



evenly distributed



evenly distributed



products meet or exceed applicable ANSI/BIFMA standards

Features



1.6" Thick Industrial Grade HDPE Blow Molded Tabletop



Fold-Flat to a Convenient Height of 3" for Easy Storage and Transportation



2.5" Umbrella Hole and Cover

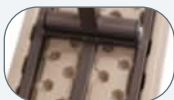

Industrial Grade 18-Gauge Framing System



Gravity Lock with Clicking Mechanism for Added Stability



Non-Marring Glides for a Secure Footing without Marking Floors

Colors



BMPT3072-BK02
Light Speckled Grey
Black Frame



BMPT3072-BR03
Brown
Brown Frame



BMPT3072-BK04
Blue
Black Frame



BMPT3072-BK06
Green
Black Frame

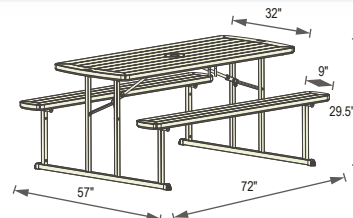

Open Overall Dimensions:
29.5" H x 57" D x 72" W

Folded dimensions:
3" H X 57" D x 72" W





PREMIUM FOLDING & FLIPPER TABLES

MAX Seating™
MSFT, MSFB



Flipper Tables
MFT



WOODEN FOLDING TABLES | MSFT SERIES
MAX Seating Tables™



Features



16-Gauge C-Channel Frame



2-Point Welded Leg Brace



14-Gauge 1.25" Square Leg Tubing Legs



Proprietary Leg Clips Secure Legs When Folded



Auto-Engage Locking Mechanism



High-Impact, Non-Marring Spring Steel Flower Glides



Folding/Locking Mechanisms Exceeded 7,000 Cycle Tests



Legs at Table Corners for Max Seating™



Nylon Corners With Standoff for Scratch-Free Stackability



14-Gauge Stability Boost Leg Brackets



products meet or exceed applicable ANSI/BIFMA standards



Leg Design Options

*Use leg code MSFE for 30" high elevated standard legs



29"H | Standard*
(MSFT)



29"H | Cantilever
(MSFTC)

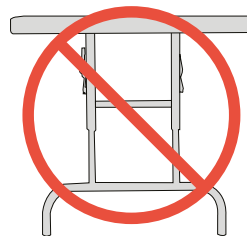

**NO WISHBONE LEGS
 FOR ZERO OBSTRUCTION
 MAX SEATING™ SPACE**

Tabletops

Custom tabletop core and surfaces available

PAGE 255 | Laminate and Edge Design Options



DESIGNED, ENGINEERED
 & ASSEMBLED IN THE
 U. S. A.

 WITH GLOBAL MATERIALS



Particleboard with T-Molding
 .75" Core | HPL Surface
 T-molding
 (PB TM)



Particleboard with 3mm PVC Edge
 .75" Core | HPL Surface
 3mm Hot-Melt PVC Edge
 (PB EB)



MDF with Protect Edge
 .75" Core | HPL Surface
 Protect Edge
 (MD PE)



Plywood with Protect Edge
 .75" Core | HPL Surface
 Protect Edge
 (PW PE)



Plywood with T-Molding
 .75" Core | HPL Surface
 T-molding
 (PW TM)



Plywood with 3mm PVC Edge
 .75" Core | HPL Surface
 3mm Hot-Melt PVC Edge
 (PW EB)

Standard Leg Placement

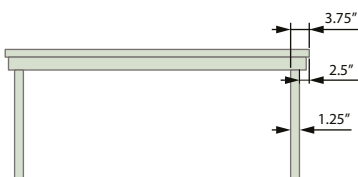

Size (Width/Length in inches)

1848	1860	1872	1884	1896
2448*	2460	2472	2484	2496
3048*	3060	3072	3084	3096
3648*	3660	3672	3684	3696
48RD	60RD	72RD	RD= Round	

● Available in Cantilever Leg
 *48" Long Rectangle Tables Do Not Fold Flat

↔ See Next Page for Custom Sizes and Recessed Leg Options

Model Number Configuration

Leg Design Code Core Edge

MSFT 2460 PW EB GY

Width/Length Laminate Color

7 Day Quickship Models:

- MSFT1872MDPECE (Carbon EV)
- MSFT1872MDPEPN (Pinnacle Walnut)
- MSFT1872MDPECE (Carbon EV)
- MSFT1872MDPEPN (Pinnacle Walnut)
- MSFT1896MDPECE (Carbon EV)
- MSFT1896MDPEPN (Pinnacle Walnut)



Custom Size Tables

Upcharge and extended lead time apply

We can build any length tabletop on the smaller size frame (up to 120" long).

We will install it onto the closest smaller size frame (60", 72", 84" & 96" Length).

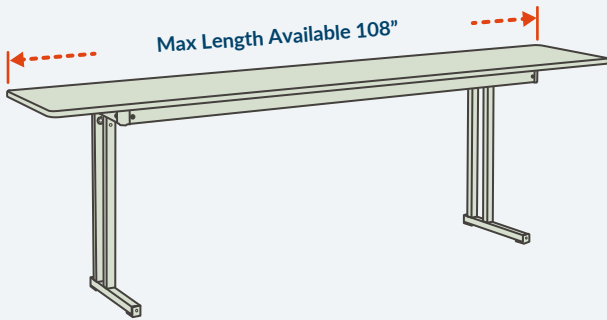

Recessed Legs

**Available only for rectangle shape | Upcharge and extended lead time apply*

Table legs can be recessed to your ideal placement to help maximize seating space. When recessing legs, only the legs for which a dimension is noted will be recessed. Any non-specified legs will be mounted at the standard placement.

To recess the right leg:

Add **R** followed by distance from the edge of the tabletop at the end of model number (i.e. R12)

To recess the left leg:

Add **L** followed by distance from the edge of the tabletop at the end of model number (i.e. L8)

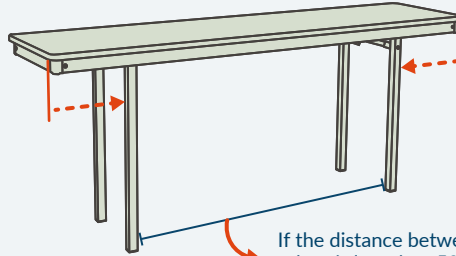

Note the dimension (in inches) from the edge of the tabletop

If the distance between legs is less than 58" Table Will Not Fold Flat



Model Number Configuration

Custom Length
MSFT 24108 PW EB GY

Model Number Configuration

Right Leg Recessed Distance from Edge
MSFT 2448 PW EB GY R12 L8
 Left Leg Recessed Distance from Edge



- Please note:**
- All testing was conducted with standard tabletop and leg configurations. Recessing legs or customizing tabletops may cause table to be susceptible to tipping.
 - Please allow up to 2 inch tolerance.



FLIPPER TABLES

FLIPPER TABLES



Roll In



*Flip It, Nest It, Love It!
The Ultimate Space-Saving
Flipper Tables*

Flip



Store



PREMIUM FOLDING & FLIPPER TABLES | MFT SERIES
Mobile Flipper Table

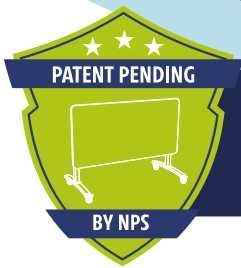

MOBILE FLIPPER TABLES
PATENT PENDING
INNOVATIVE ENGINEERING AND DESIGN



Choose Your Perfect Fit with
3 Heights & **30+ Table Top Sizes**

Mobile Flipper Table



Dual Handle for Easy Flip

A dual-handle mechanism designed for smooth and controlled flipping of the tabletop, ensuring convenience and durability.

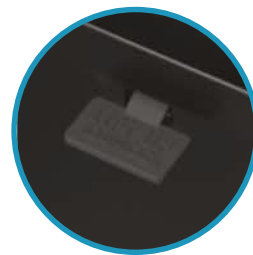

Safety Lock

Automatically engages when the tabletop flips up, securely catching it in place to ensure stability during transit or movement and prevent accidental falls. Simply lift the handle to release and set up the tabletop.



Nesting Bumpers



Curved Base Design

An elegantly curved base that enhances stability and adds a touch of sophistication to any space.



Heavy-Duty Construction

Featuring gussets and clamped leg connections secured with robust bolts, designed to endure heavy use while maintaining exceptional structural integrity.





THREE HEIGHTS AVAILABLE



29" TABLE HEIGHT



36" TABLE HEIGHT



42" TABLE HEIGHT

Features



Heavy Duty 3" Locking Casters



11-Gauge Steel Frame



Automatic Safety Lock



Tables Flip and Nest for Simple Storage

Model Number Configuration

Model Number | Height
MFT10 2448 1 MDPE GY
 Width/Length | Top | Laminate Color (if Applicable)

Tabletop Options



1.2" MDF Core
 HPL Surface
 Protect Edge (MDPE)



1.2" Particleboard Core
 HPL Surface
 T-Mold (PBTM)



1.2" Particleboard Core
 HPL Surface
 3mm Hot-Melt PVC Edge (PBEB)



Whiteboard
 1.2" Particleboard Core
 Markerboard HPL Surface
 PVC Edge Banding (WB)

PAGE 255 | Laminate and Edge Design Options

Rectangular Size (Width/Length in inches)

1848	1860	1872	1896
2448	2460	2472	2496
3048	3060	3072	3096
3648	3660	3672	3696
4248	4260	4272	4296
4848	4860	4872	4896

Round (Diameter in inches)

48RD	60RD
------	------

Height Description

1	29" Dining Height
2	36" Counter Height
3	42" Bar Height



evenly distributed





5/7
First Team work to give us
"what"
personal aspects
Tables in use in Lab 20
- Introduction of your day
- deba - Efficiency
- Shared writing
- Learning

5/8/15
First Team work to give us
"what"
personal aspects
Tables in use in Lab
- Introduction of your day
- deba - Efficiency
- Shared writing



STEEL TABLES

Titan
TT



Heavy Duty
HDT, HDTD, HDTA



**Heavy Duty
Accessories**
TRAY-KIT, TBK



Titan Table



Features



14-Gauge Legs Are Set at a 94 Degree Angle



Tamper-Free Hardware



Super-Duty Sheet-Metal Apron Design



Undertable Hat Structure for Ultimate Durability



Legs Are Fastened With a Double Bolt and Four Screw Connection



6 Millimeter Thick Foot Plate for Extreme Strength



Tables Ship With Frame Pre-Installed



Apron Is Constructed from 14-Gauge Steel

THREE HEIGHTS AVAILABLE

Frame Color



Soft Grey

Titan Table



Enhance your Makerspace with Tote Tray Storage!
Compatible with Tables 48" and wider
See Page 95 for Tote Kit Information



Heights

30" (1) 36" (2) 40" (3)

Model Number Configuration

Prefix Casters/Glides Top
TT02-2448 G 1 PBTM GY
 Width/Length Height Laminate Color (if applicable)

Table Foot Options



4" Lock Casters
Constructed with Polyamide Plus TPU Tread (C)



Super-Duty Steel Glides
Powercoated Grey Felt base rubber foot (G)

Size (Width/Length in inches)

2436	2442	2448	2454	2460	2472	2484	2496
3036	3042	3048	3054	3060	3072	3084	3096
3636	3642	3648	3654	3660	3672	3684	3696
4242	4248	4254	4260	4272	4284	4296	
4848	4854	4860	4872	4884	4896		

- Quick ship tables available, choose from tops B, W, C, P
- Quick ship tables available, choose from tops P and C
- Quick ship tables available with top C only

Standard lead time is 8 weeks. Quick ship lead time is 7 days.

Tabletops



High Pressure Laminate
1.2" Particleboard Core
HPL Surface | T-molding (PBTM)



High Pressure Laminate
1.2" MDF Core
HPL Surface | Protect Edge (MDPE)



Whiteboard
1.2" Particleboard Core
Markerboard HPL Surface | PVC Edge Banding (W)



Chem-Res
1" Particleboard Core
Chemical Resistant Top Edge Banding (C)



Phenolic
.75" Solid Phenolic
Designer Beveled Edges (P)



Trespa
.75" Cellulose Core
Designer Beveled Edges (T)



Butcherblock
1.75" Solid Maple Wood
Proprietary UV Finish (B)

See Back for warranty, finish options and care instructions.

PAGE 255 | Laminate and Edge Design Options



products meet or exceed applicable ANSIBIFMA standards



STEEL TABLES | HDT SERIES
Heavy Duty Tables





MORE THAN
2,000
DESIGN VARIATIONS

STEEL TABLES | HDT SERIES

Heavy Duty Tables Specs

The **NPS Heavy Duty Table** is ideal for any makerspace environment. The 16-Gauge apron and 14-Gauge legs make this table virtually indestructible. Available with either fixed or adjustable height legs. Adjustable legs can be raised in 1" increments and are locked firmly in place with 2 K-9 external tooth lock washers and heavy duty tamper-free hex screws. All legs come standard with simple-adjust glides and have a caster option for easy mobility. **Play. Work. Study.**



Exceeds 500lbs.
Static Weight
Capacity

Tabletops



Standard High Pressure Laminate
.75" particleboard core
HPL Surface | T-molding (HPBTM)



Supreme High Pressure Laminate
1.2" MDF core
HPL Surface | Protect Edge (SMDPE)



Whiteboard
1.2" Particleboard Core
Markerboard HPL Surface
| PVC Edge Banding (W)



Chem-Res
1" Particleboard Core
Chemical Resistant Top
Edge Banding (C)

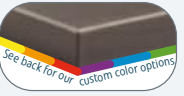

Phenolic
.75" Solid Phenolic
Designer Beveled Edges (P)
See back for our custom color options



Trespa
.75" Cellulose Core
Designer Beveled Edges (T)



Epoxy
1" Solid Epoxy
Designer Beveled Edges (E)



Butcherblock
1.75" Solid Maple Wood
Proprietary UV Finish (B)
See back for warranty, finish options and care instructions.

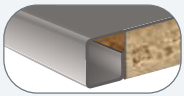

Stainless Steel Safety Return
1.75" Particleboard Core
Grade 304 Stainless Steel Top (STRET)
See back for more info and care instructions.

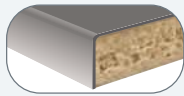

Stainless Steel Straight Edge
1.75" Particleboard Core
Grade 304 Stainless Steel Top (ST)
See back for more info and care instructions.

Table Sizes

Width Options

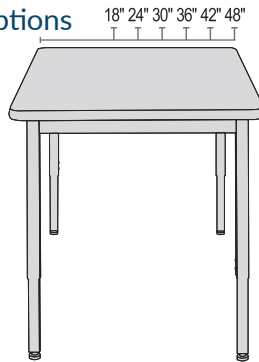

Length Options

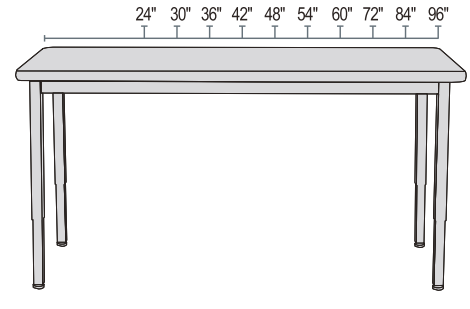

Leg Construction

Fixed Height Legs:



Adjustable Height Legs:



Standard Features



Corner Brackets
Bolted Onto Frame



Dual-Side Leg
Connection



Welded 12-Gauge
Leg Top Plate



Adjustable Legs
Adjust in 1"
Increments



11-Gauge Welded
Support Brackets



16-Gauge
Channel Frame



Leveling Glides
Can Add up to 3/4"
Height to Table



Legs Built with
1-1/2" Square Tubing
14 Gauge Thickness

PAGE 255 | Laminate and Edge Design Options

Optional Accessories

Casters

3" Heavy-Duty Casters



- 4 Heavy Duty Swivel Locking Casters
- Increases the Table Height by 3¼"
- A Set of Gussets Is Included With Casters

Corner Gussets



- 13-Gauge Steel
- Tamper-Free Hardware
- All tables wider than 30", longer than 72" will include a set of gussets
- Recommended When Using Tables Above 30" High

Peg Boards

Available for 24" and 30" Tables



- Two 16-Gauge Industrial Grade Peg Boards Included in Each Set
- Variety Set of 50 7-Gauge Chromed Pegs Included With Each Peg Board Set
- Holes Spaced 1" Apart
- Assembled With Tamper-Free Self-Tapping Screws



Model Number Configuration

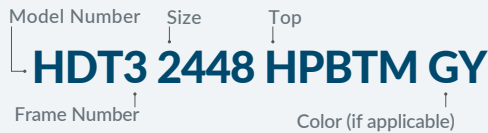

All tables wider than 30", longer than 72", or with Epoxy/Trespa/Stainless Steel tabletops will include a set of gussets

Accessories Model Number Configuration

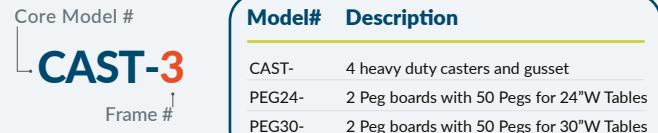

(for example, "3" should be used for accessories used for table frame # HDT3)

Frame#	Description
HDT3	Heavy Duty Table, Height Adjustable, Textured Black
HDT7	Heavy Duty Table, Fixed Height Legs, Textured Black
HDT8	Heavy Duty Table, Height Adjustable, Soft Grey
HDT9	Heavy Duty Table, Fixed Height Legs, Soft Grey

Size (Width/Length in inches)										
1824	1830	1836	1842	1848	1854	1860	1872	1884	1896	
2424	2430	2436	2442	2448	2454	2460	2472	2484	2496	
3030	3036	3042	3048	3054	3060	3072	3084	3096		
3636	3642	3648	3654	3660	3672	3684	3696			
4242	4248	4254	4260	4272	4284	4296				
4848	4854	4860	4872	4884	4896					

- Quick ship tables available, choose from tops B, W, and H with grey nebula laminate
- Quick ship tables available with top S with grey nebula laminate only
- Quick ship tables available with top B only

Standard lead time is 8 weeks. Quick ship lead time is 7 days.

Top	Description/Edge
B	1.75" Solid Maple Butcherblock/UV Finish
W	1.25" Whiteboard/PVC Edge Banding
HPBTM	.75" Standard High Pressure Laminate with T-Mold
SMDPE	1.25" Supreme High Pressure Laminate with Protect Edge
C	1" Chem-Res/3mm Edge Banding
P	.75" Solid Phenolic/Beveled Edge
T	.75" Solid Trespa/Beveled Edge
E	1" Solid Epoxy/Beveled Edge
STRET	1.75" Stainless Steel with Safety Return Edge
ST	1.75" Stainless Steel with Straight Edge

Using Epoxy tables in mobile applications with casters voids the warranty.

Frame Color Options



Textured Black

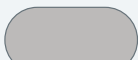

Soft Grey



products meet or exceed applicable ANSI/BIFMA standards





Heavy-Duty Tables with a Designer Touch!





*Innovative
Designer Apron*



EXCLUSIVELY PATENTED



HEAVY-DUTY DESIGNER TABLE
PATENTED
INNOVATIVE ENGINEERING AND DESIGN

BY NPS

Heavy Duty Designer Tables



*Discover the perfect blend of form and function
with our **NPS Heavy-Duty Designer Tables!***

MORE THAN 2,000 DESIGN VARIATIONS!



STEEL TABLES | HDTD SERIES

Heavy Duty Designer Table Specs

Tabletops



High Pressure Laminate
1.2" Particleboard Core
HPL Surface | T-molding
(PBTM)



High Pressure Laminate
1.2" MDF Core
HPL Surface | Protect Edge
(MDPE)



Whiteboard
1.2" Particleboard Core
Markerboard HPL Surface
PVC Edge Banding
(W)



Chem-Res
1" Particleboard Core
Chemical Resistant Top
Edge Banding
(C)



Phenolic
.75" Solid Phenolic
Designer Beveled Edges
(P)



Trespa
.75" Cellulose Core
Designer Beveled Edges
(T)



Epoxy
1" Solid Epoxy Resin
Designer Beveled Edges
(E)



Butcherblock
1.75" Solid Maple Wood
Proprietary UV Finish
(B)

See back for warranty, finish options and care instructions.

PAGE 255 | Laminate and Edge Design Options

Standard Features



Innovative Designer Apron



Corner Brackets Bolted Onto Frame



Welded 12-Gauge Leg Top Plate



4-Gauge Full-Length Apron Support Plate



Designer Apron ADA Compliant



Adjustable Legs Adjust in 1" Increments



Leveling Glides Can Add up to 3/4" Height to Table



Exceeds 500lbs. Static Weight Capacity

Table Sizes

Width Options

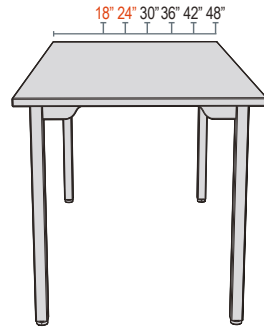

Length Options

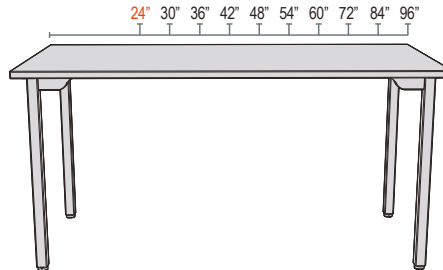

All Widths/Lengths smaller than 30" feature Standard Non-Designer Aprons

Leg Construction

Fixed Height Legs:



Adjustable Height Legs:

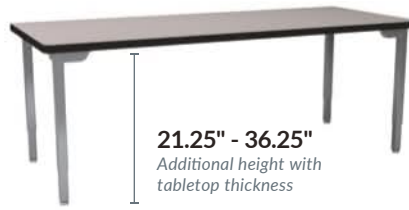

Size (Width/Length in inches)

1824	1830	1836	1842	1848	1854	1860	1872	1884	1896
2424	2430	2436	2442	2448	2454	2460	2472	2484	2496
3030	3036	3042	3048	3054	3060	3072	3084	3096	
3636	3642	3648	3654	3660	3672	3684	3696		
4242	4248	4254	4260	4272	4284	4296			
4848	4854	4860	4872	4884	4896				

- Quick ship tables available, choose from tops B, W, C, P, and PBTM with grey nebula laminate
- Quick ship tables available, choose from tops P and C
- Quick ship tables available with top C only

Standard lead time is 8 weeks. Quick ship lead time is 7 days.

Optional Accessories

Casters



Optional 4 Heavy-Duty Swivel Locking 3" Casters
Increases the Table Height by 3 1/4"

Model Number Frame #
CAST-D X

Corner Gussets



11-Gauge Steel Gussets, Featuring Tamper-Free Hardware

Model Number Frame #
GUSD-XX
Frame Color (Black "10" or Grey "02")

Peg Boards



Two 16-gauge steel Peg Boards assembled with tamper-free screws and 50 7-gauge chromed pegs spaced 1" apart.

Model Number Frame #
PEG 24-X
Size (24" or 30" Width)

Frame# Description

● 3	Height Adjustable, Textured Black
● 7	Fixed Height Legs, Textured Black
● 8	Height Adjustable, Soft Grey
● 9	Fixed Height Legs, Soft Grey

Model Number Configuration

Model Number Frame Code Tabletop
HDTD 3 3060 PBTM GY T

Size Laminate Color (if applicable)

Add "T" here for Pre-Installed Tote Tray Holders
See Page 95 for Tote Tray Holder Specs



STEEL TABLES | HDTA SERIES
Heavy Duty Activity Tables





Classroom Innovation:

*Elevate Learning with Our Dynamic Shape-Shifting
Heavy-Duty Activity Tables!*

Heavy Duty Activity Tables Shapes

One Table System. Endless Possibilities.

25+ SHAPES TO CHOOSE FROM!

See Page 266

Perfect for collaboration



Designed to Move with Students



Great for Flexible Layouts

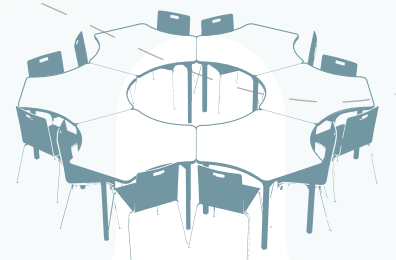

Versatile shapes designed to mix, match, and adapt.
Choose from multiple colors, finishes, and
leg options to create engaging learning spaces.



Heavy Duty Activity Table Specs



Exceeds 500lbs. Static Weight Capacity

Standard Features



Heavy-Duty Activity 11-Gauge Leg Mount



Dual-Side Leg Connection



Additional Reinforcement Screws



ADA Compliant



Adjustable Legs Adjust in 1" Increments



Patent Pending Leg Mount Gusset Design



Welded 12-Gauge Leg Top Plate



Leveling Glides Can Add up to 3/4" Height to Table

Tabletops

PAGE 255 | Laminate and Edge Design Options



High Pressure Laminate

1.2" MDF Core
HPL Surface | Protect Edge (MDPE)



High Pressure Laminate

1.2" Particleboard Core
PVC Edge Banding (PBEB)



High Pressure Laminate

1.2" Particleboard Core
HPL Surface | T-molding (PBTM)



Whiteboard

1.2" Particleboard Core
Markerboard HPL Surface
PVC Edge Banding (W)



Chem-Res

1" Particleboard Core
Chemical Resistant Top
Edge Banding (C)

Casters

Model Number
SLT-CAST



Optional 4 Heavy-Duty Swivel Locking 3" Casters

Increases the Table Height by 3 3/4"

Leg Construction

Fixed Height Legs:

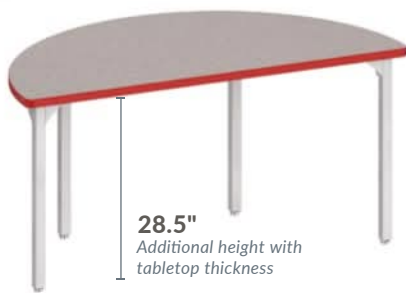

Adjustable Height Legs:

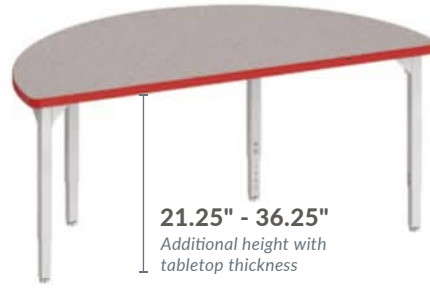

Frame Color Options



Textured Black



Soft Grey

Frame#	Description
3	Height Adjustable, Textured Black
7	Fixed Height Legs, Textured Black
8	Height Adjustable, Soft Grey
9	Fixed Height Legs, Soft Grey

Shapes and Sizes



Trapezoid Sizes (TZ)
(Width/Length in Inches)

2448	2454	2460	2472
3054	3060	3072	



Tri Sizes (TR)
(Width/Length in Inches)

2454	2460
3054	3060



Hexa Sizes (HX)
(Width/Length in Inches)

2454	2460	2472
3060	3072	



Square Sizes (SQ)
(Width in Inches)

24	30	36	42	48
----	----	----	----	----



Semicircle Sizes (SC)
(Diameter of Full Circle in Inches)

48	60
----	----



Round Sizes (RD)
(Diameter in Inches)

36	42	48	60
----	----	----	----



Rectangle Student Desk Sizes (RC)
(Width/Length in Inches)

2028	2230	2436
------	------	------



More Shapes and Sizes on Page 266



Model Number Configuration

Model Number Shape Tabletop
HDTA 3 TZ 3060 PBTM GY
 Frame Number Size Laminate Color (if applicable)



products meet or exceed applicable ANSI/BIFMA standards



Tote Tray Holder

Get Tote-ally Organized!



Tote Tray Holder

Tray Holder Dimensions 15.8" L x 12.9" W x 1.7" H

Create an Organized and Inviting Learning Atmosphere with Multishaped Tables and Integrated Tote Tray Holders, Tailored for Educational Excellence

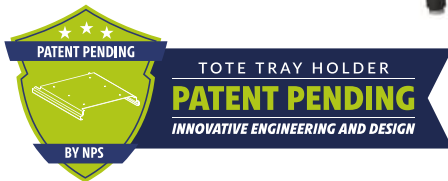
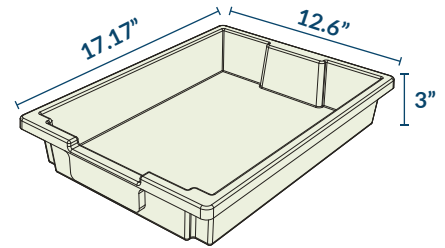

SIMPLE ASSEMBLY TRAY HOLDERS

Compatible Tables: HDTD Series 30" and wider, HDTA Series, Titan Series 48" and wider, and CT Series.

Features



Trays are Made of Heavy-Duty Translucent Polypropylene Material



Tray Holders Feature a Single Rail Made of 14-Gauge Steel



Trays Feature Built-In Name Card Slots



Trays Feature a Built-in Handle and Smooth Edges

Holder Color Options



Textured Black (10)

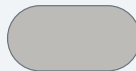

Soft Grey (02)

Model Number Configuration

Tote Tray Holder Prefix

TOTE-KIT-10

Tray Holder Color

Perfect Match!

Use with our Mobile Science Cart with Tote Trays MSC04



Robotics Bumper Kit



*Discover the future of robotic safety with our versatile and heavy-duty **Robotics Bumper Kit**! Ideal for all types of robotic environments, this kit can be seamlessly installed on almost any rectangular table, both new and existing.*

STEEL TABLES | TBK SERIES Robotics Bumper Kit Specs

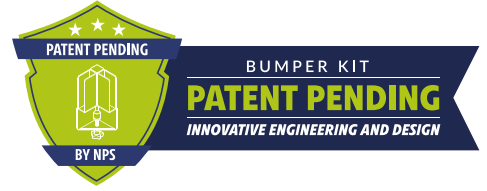

Convert any Table into a Fun Hub with Our Easy-Install Bumper Kit!



Kit Includes:

- 4 Corner Brackets
- 4 Side Clamps
- 4 Bumper Panels



**TOOL FREE
INSTALLATION**

Personalized for You!

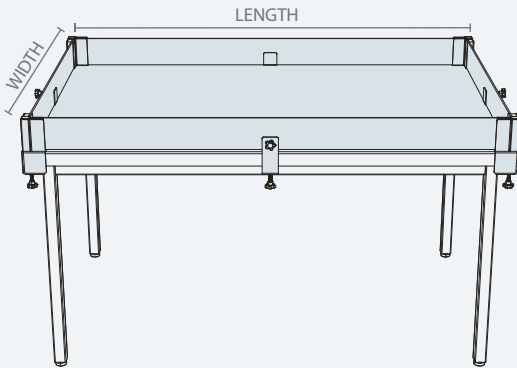

Specify the width and length of your rectangular tabletop for your Bumper Kit preparation, ensuring it is of the same size. Ensure there are no obstructions within 1.5 inches from the edge of the tabletop so that the bumper system can be securely mounted.

Note: Compatible with all NPS Rectangular Tables except SLT6 and MSFT

Standard Features



Simplified Setup with Tool Free Assembly



Compatible with Tabletops up to 1.75" thick



Center Clamps for Ultimate Security



Unique Bumper Style Compatible with Wood or Acrylic Panels



Heavy-Duty Knob Assembly Ensures Unit is Secure when in Use and Allows for Simple Takedown



Corner Brackets and Side Clamps are constructed of 13-Gauge and 6-Gauge Steel Parts

Bumper Type Bumper Panels are 4" High



Optix® Acrylic Bumper
Clear Acrylic (CA)



Wood Bumper
Particleboard Core
HPL Black Surface
PVC Edge Banding (PBEBBK)

Corners Color

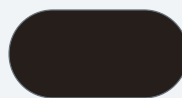

Black Powdercoating

Model Number Configuration

Prefix | Bumper Type
TBK-3072-CA
Width/Length



AERO-LIFT TABLES



AERO-LIFT TABLES



Introducing...

the NEW Aero-Lift Tables Series:

Elevate Your Space!

CHOOSE YOUR PERFECT STYLE

WOOD FRAME TABLE



STEEL DESIGNER FRAME TABLE



STEEL FRAME TABLE



ACTIVITY TABLE



SIGNATURE TABLE



Designed for Every Space!



Precision in Every Lift:
Aero-Lift Leg System
Adjusts Without Power, and
Stays Steady at Any Height.

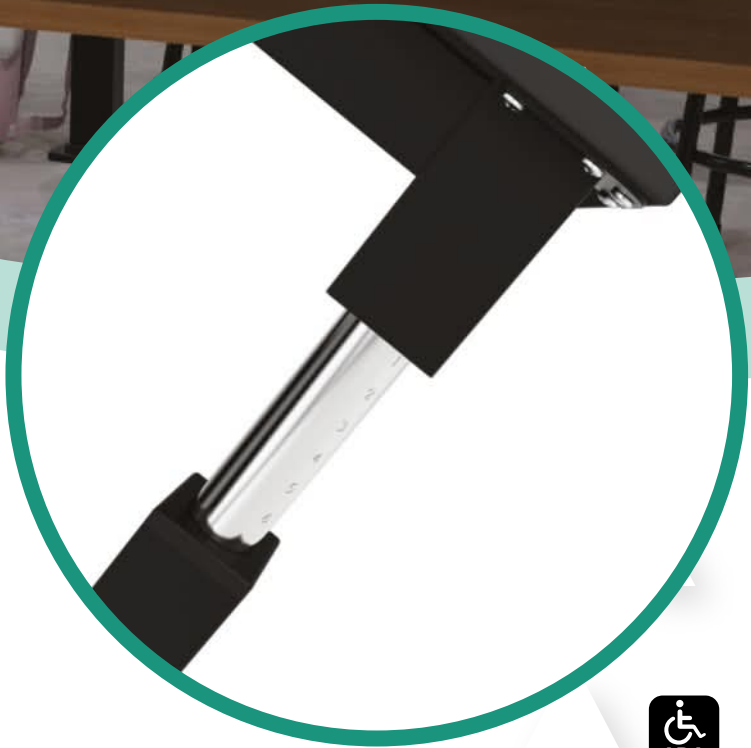

UNIQUE FEATURES



Super Duty 6-Gauge Steel
Leg Brackets Secure
Legs to Tabletop

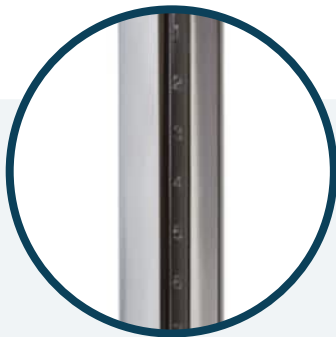

Legs Adjust in 3/4"
Increments from 27"-42"H
Featuring Laser Marked
Level Numbers



Legs are constructed with
2 3/8" Square 16-Gauge
Powercoated Black
Steel Tubing



Extended Footprint Glides
On The Legs Offer A Secure
Grip When Adjusting



Wood Frame Tables



Tabletops



Science HPL
1.2" Particleboard Core
HPL Black Surface | T-molding (L)



Chem-Res
1" Particleboard Core
Chemical Resistant Top
Edge Banding (C)



High Pressure Laminate
.75" Particleboard Core
HPL Surface | T-molding (HPBTM)



Phenolic
.75" Solid Phenolic
Designer Beveled Edges (P)



High Pressure Laminate
.75" MDF Core
HPL Surface | Protect Edge (HMDPE)



Epoxy
1" Solid Epoxy Resin
Designer Beveled Edges (E)



High Pressure Laminate
1.2" Particleboard Core
HPL Surface | T-molding (SPBTM)



Trespa
.75" Cellulose Core
Designer Beveled Edges (T)



High Pressure Laminate
1.2" MDF Core
HPL Surface | Protect Edge (SMDPE)



Butcherblock
1.75" Solid Maple Wood
Proprietary UV Finish (B)



Whiteboard
1.2" Particleboard Core
Markerboard HPL Surface
PVC Edge Banding (W)

See back for warranty, finish options and care instructions.



Features

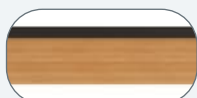

Solid Ash Frame



Legs Attach with Metal on Metal Double Bolt Assembly



Available With Book Compartments



See Page 101 for Shared Features

Casters

Model Number
CAST-ALT



Optional 4 Heavy-Duty Swivel Locking 3" Casters

Increases the Table Height by 3¼"



products meet or exceed applicable ANSI/BIFMA standards



Size (Width/Length in inches)

2430	2442	2448	2454	2460	2472
3030	3042	3048	3060	3072	

Model Number Configuration

Model Number Size Top Add-Ons

ALT10 -WA 2448 SPBTM GY B

Laminate Color (if applicable)

Add-on Description

Add-on	Description
B	Book Compartments



Tabletops



Chem-Res
1" Particleboard Core
Chemical Resistant Top
Edge Banding (C)



Phenolic
.75" Solid Phenolic
Designer Beveled Edges (P)



Epoxy
1" Solid Epoxy Resin
Designer Beveled Edges (E)



Trespa
.75" Cellulose Core
Designer Beveled Edges (T)



Butcherblock
1.75" Solid Maple Wood
Proprietary UV Finish (B)
See back for warranty, finish options and care instructions.



See Page 101 for Shared Features

Features



11-Gauge Welded Support Brackets



16-Gauge Channel Frame



Legs Attach with Metal on Metal Double Bolt Assembly

Casters

Model Number
CAST-ALT



Optional 4 Heavy-Duty Swivel Locking 3" Casters
Increases the Table Height by 3/4"

Size (Width/Length in inches)

	1842	1848	1854	1860	1872
2424	2430	2436	2442	2448	2454
	3030	3036	3042	3048	3054
				3060	3072

Model Number Configuration

Model Number | Size | Top
ALT10 -SB 2448 C
Frame Color

Frame Color Options



Textured Black (SB)



Soft Grey (SG)



products meet or exceed applicable ANSI/BIFMA standards



AERO-LIFT TABLES | ALT SERIES

Designer Steel Frame Tables



Innovative Designer Apron

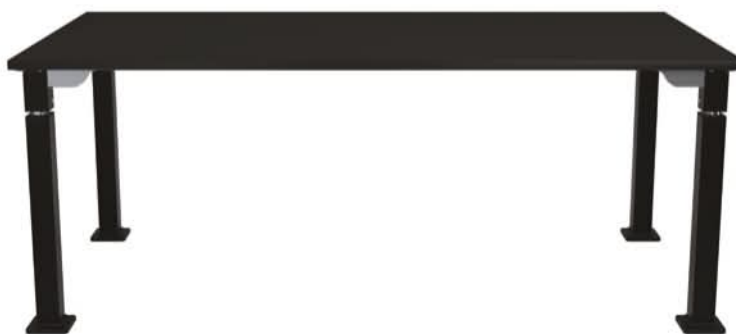

Tabletops



Chem-Res
1" Particleboard Core
Chemical Resistant Top
Edge Banding (C)



Phenolic
.75" Solid Phenolic
Designer Beveled Edges (P)



Epoxy
1" Solid Epoxy Resin
Designer Beveled Edges (E)



Trespa
.75" Cellulose Core
Designer Beveled Edges (T)



Butcherblock
1.75" Solid Maple Wood
Proprietary UV Finish (B)
See back for warranty, finish options and care instructions.

See Page 101 for Shared Features

Features



Innovative Designer Apron



4-Gauge Full-Length Apron Support Plate



Legs Attach with Metal on Metal Double Bolt Assembly

Casters



Optional 4 Heavy-Duty Swivel Locking 3" Casters

Increases the Table Height by 3¼"

Model Number
CAST-ALT

Size (Width/Length in inches)

	1842	1848	1854	1860	1872	
2430	2436	2442	2448	2454	2460	2472
3030	3036	3042	3048	3054	3060	3072

Please Note:



All Widths/Lengths smaller than 30" feature Standard Non-Designer Aprons



Frame Color Options



Textured Black (DB)



Soft Grey (DG)



products meet or exceed applicable ANSI/BIFMA standards



Model Number Configuration

Model Number | Size | Top
ALT10 -DB 2448 C
Frame Color



Shape Your Vision, Lift Your Ideas

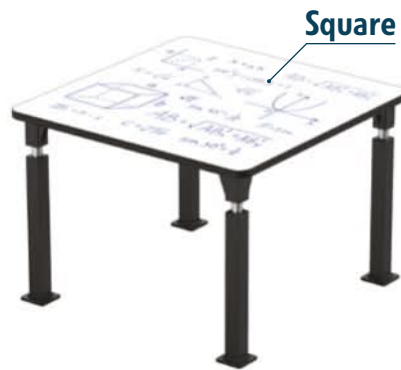

Solid Support, Sleek Design:
Featuring Super-Duty Brackets that Perfectly Anchor the Aero-Lift Legs

NEW
More SHAPES & SIZES on Page 266

See Page 101 for Shared Features

Tabletops PAGE 255 | Laminate and Edge Design Options

High Pressure Laminate 1.2" MDF Core HPL Surface Protect Edge (SMDPE)	High Pressure Laminate 1.2" Particleboard Core PVC Edge Banding (SPBEB)	High Pressure Laminate 1.2" Particleboard Core HPL Surface T-molding (SPBTM)	Whiteboard 1.2" Particleboard Core Markerboard HPL Surface PVC Edge Banding (WB)	Chem-Res 1" Particleboard Core Chemical Resistant Top Edge Banding (C)

Casters Model Number **CAST-ALT**

Optional 4 Heavy-Duty Swivel Locking 3" Casters
Increases the Table Height by 3/4"

Model Number Configuration

Model Number | Shape | Tabletop
ALT10A - TZ 3060 SPBTM GY
 Size | Laminate Color (if applicable)

7 DAY QUICK SHIP OPTIONS AVAILABLE

BIFMA INTERNATIONAL
ANSI
products meet or exceed applicable ANSI/BIFMA standards

10 Year warranty

CERTIFIED GREEN

Signature Tables

Tabletops



Science HPL

1.2" Particleboard Core
HPL Black Surface | T-molding (L)



Particleboard with 3mm PVC Edge

1.2" Core | HPL Surface
3mm Hot-Melt PVC Edge (PBEB)



Particleboard with T-Molding

1.2" Core | HPL Surface
T-molding (PBTM)



MDF with Protect Edge

1.2" Core | HPL Surface
Protect Edge (MDPE)



Whiteboard

1.2" Particleboard Core
Markerboard HPL Surface
PVC Edge Banding (W)



Chem-Res

1" Particleboard Core
Chemical Resistant Top
Edge Banding (C)



Phenolic

.75" Solid Phenolic
Designer Beveled Edges (P)



Butcherblock

1.75" Solid Maple Wood
Proprietary UV Finish (B)

See back for warranty, finish options and care instructions.

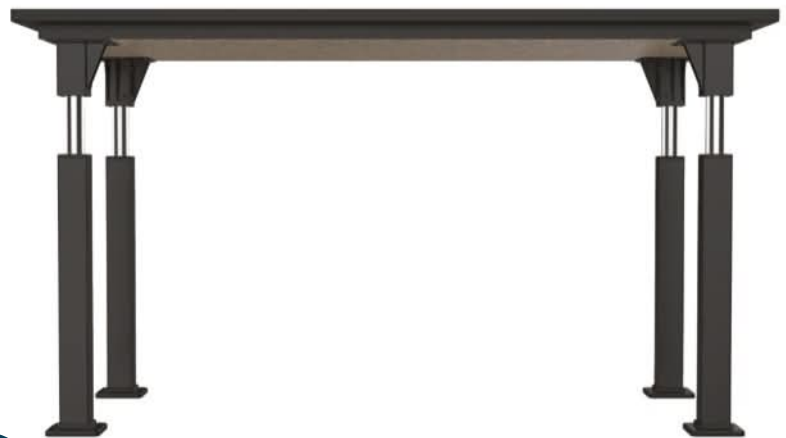

Features



1.2" Thick Reinforcement Board Under Tabletops for Added Strength



Super-Duty Brackets Perfectly Anchor the Aero-Lift Legs



11-Gauge Brackets Fastened to Tabletop with 9 Heavy-Duty Screws

Casters

Model Number
CAST-ALT



Optional 4 Heavy-Duty Swivel Locking 3" Casters
Increases the Table Height by 3/4"

Size (Width/Length in inches)

2448	2454	2460	2472
3060			

Model Number Configuration

Model Number Size Top

ALT10-SI - 2448 PBEB GY

Laminate (if applicable)



products meet or exceed applicable ANSI/BIFMA standards







SCIENCE

Science Cabinet
MSC



Science Workstation
WSH



Science Tables
SLT1, SLT2, SLT3,
SLT7, SLT8, SLT9,
SLTD, SLTA



Aero-Lift Tables
ALT



MOBILE SCIENCE CABINETS



WHITEBOARD/MIRROR
for Most Models

SINK OPTION
for Most Models

INTRODUCING

A FULL LINE OF FULLY ASSEMBLED*
Mobile Science Cabinets

BUILT-IN POWERSTRIP
on Most Models



**CUSTOM TOPS
AVAILABLE**



**HEAVY-DUTY
CONSTRUCTION**



**BUILT-IN
MAGNETIC GANGING**

*Caster Assembly Required

SCIENCE CABINETS | MSC SERIES
Mobile Science Cabinets



New CUSTOM
 COLOR OPTIONS!

NEW

18 New TFL Custom Color Options

See All Options on Page 263

A Cabinet for Everyone!

Models



Shared Features



All Carts Include
 4 Swivel Casters,
 2 Locking

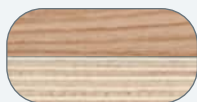

Oak Veneer Plywood Core
 Cabinet and Shelves



Modern Two-Tone
 Black Edge and Hardware
 on Oak Panel Look



Doors Feature Five-knuckle
 Wrap-Around Hinges



Doors/Drawers Lock
 To Keep Contents Safe



Magnetic Ganging to Connect
 Multiple Cabinets and Form
 a Worksurface



All Carts are the Same
 Height (Excluding MSC05),
 to Enable Seamless
 Connection with Gangers



10-Outlet + 4 USB Input
 Surge Protected Power Strip,
 15ft Cord, and Built-in Hook
 (Available only for MSC01,
 MSC02, MSC03, and MSC06)

Tabletops



Chem-Res
 1" Particleboard Core
 Chemical Resistant Top
 Edge Banding
 (Standard)



Phenolic
 .75" Solid Phenolic
 Designer Beveled Edges
 (Add code "P")

Mobile Science Cabinet

with Shelving

Maximize Storage and Efficiency with Our Science Cabinet Featuring Two Long Shelves!



Standard Chem-Res Model#
MSC01
Phenolic Model#
MSC01P

Dimensions
Overall 28"W x 48"L x 36.25"H



Two Adjustable Height Shelves

See Page 112 for Shared Features



Mobile Science Cabinet

with Inner Drawers and Shelf

Unleash Organization with 4 Inner Drawers + 1 Shelf



Four Concealed Drawers

Adjustable Height Shelf

Dimensions
Overall 28"W x 48"L x 36.25"H

Standard Chem-Res Model#
MSC02
Phenolic Model#
MSC02P



Mobile Science Cabinet

with External Drawers and Pegboard

Smart Science, Smart Storage – Unleash the Possibilities.



Three External Drawers and a Pull-out Shelf on Slides



Pullout Pegboard With 50 Assorted Pegs

Adjustable Height Shelf

Standard Chem-Res Model#

MSC03

Phenolic Model#

MSC03P

Dimensions

Overall 28"W x 48"L x 36.25"H



See Page 112 for Shared Features



Mobile Science Cabinet

with Inner Drawers and Pegboard

Optimize Space with 4 Inner Drawers + 1 Pegboard.



Four Concealed Drawers

Pullout Pegboard With 50 Assorted Pegs

Standard Chem-Res Model#

MSC06

Phenolic Model#

MSC06P

Dimensions

Overall 28"W x 48"L x 36.25"H



Mobile Science Cabinet

with Tote Trays

Where Organization Meets Mobility: 24 Tote Trays in Our Mobile Science Cabinet.



Trays Feature Built-In Name Card Slots



Trays Feature a Built-in Handle and Smooth Edges



SHIPS WITH
24 TOTE TRAYS

Made of Heavy-Duty Translucent Polypropylene Material



Removeable Storage Trays Nest when Not in Use

Standard Chem-Res Model#

MSC04

Phenolic Model#

MSC04P

Dimensions

Overall 28"W x 48"L x 36.25"H

Trays 12.5"W x 17"L x 3"H



See Page 112 for Shared Features



7 DAY QUICK SHIP



Mobile Science Cabinet

with Microscope Dividers

See More, Store More – Dual-Sided Microscope Storage.



HOLDS UP TO **24 MICROSCOPES**



Adjustable Height Removable Shelf on Each Side



Removable Microscope Dividers to Maximize Storage Options

Doors Open on Both Sides of Cart with Five-Knuckle Wrap-Around Hinges

Standard Chem-Res Model#

MSC05

Phenolic Model#

MSC05P

Dimensions

Overall 28"W x 48"L x 41.5"H



Demo Cabinet



New CUSTOM COLOR OPTIONS!

18 New TFL Custom Color Options

See All Options on Page 263

DEMO CABINETS

*Showcase Science Like Never Before:
Empower Your Experiments with Our
Advanced Demonstration Cabinet!*

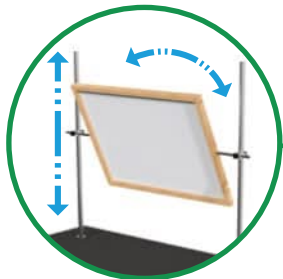

Adjust the **Height and Tilt** according to your needs

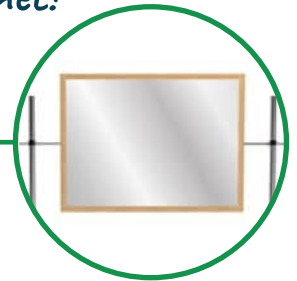

Dual purpose:
Whiteboard & Mirror
framed in solid wood



**Stainless Steel Sink with
a Hand Pump Faucet**



Two Jugs included with Sink Option.
Fill one with water and use
the other for disposal



**10-Outlet + 4 USB Input
Surge Protected Power Strip,
15ft Cord, and Built-in Hook**

Dimensions

Overall	28"W x 48"L x 69.93"-79.15"H
Cabinet	28"W x 48"L x 36.25"H
Whiteboard/ Mirror	.75"W x 27.72"L x 20.63"H
Sink	11"W x 12.5"L x 6"H



Demo Cabinet

with Open Storage Area

Models

Sink & Whiteboard/Mirror	MSC01*WS
Only Whiteboard/Mirror	MSC01*W
Only Sink	MSC01*S

*Chem-Res Standard Tabletop. Add "P" here for phenolic tabletop.



Open Storage Area
When Sink Is In Use



See Page 112 & 116
for Shared Features



Demo Cabinet

with Inner Drawers

Models

Sink & Whiteboard/Mirror	MSC02*WS
Only Whiteboard/Mirror	MSC02*W
Only Sink	MSC02*S

*Add "P" here for phenolic tabletop



Four Concealed Drawers



Open Storage Area
When Sink Is In Use

Demo Cabinet

with External Drawers and Pegboard



Three External Drawers and a Pull-out Shelf on Slides

Models

Sink & Whiteboard/Mirror	MSC03*WS
Only Whiteboard/Mirror	MSC03*W
Only Sink	MSC03*S

**Add "P" here for phenolic tabletop*



Pullout Pegboard With 50 Assorted Pegs

See Page 112 & 116 for Shared Features



Demo Cabinet

with Inner Drawers and Pegboard

Models

Sink & Whiteboard/Mirror	MSC06*WS
Only Whiteboard/Mirror	MSC06*W
Only Sink	MSC06*S

**Add "P" here for phenolic tabletop*



Pullout Pegboard With 50 Assorted Pegs



Four Concealed Drawers



SCIENCE CABINETS | MSC SERIES Specs



MSC01



MSC02



MSC03



MSC04



MSC05



MSC06

Uniques Features	-Two adjustable height shelves	-Adjustable height shelf -Four concealed drawers	-Adjustable height shelf -Three external drawers -External Pullout shelf on sliders -Pullout Pegboard with 50 assorted Pegs	-24 Removable storage Tote Trays made of heavy-duty translucent polypropylene material.	-Dual side storage -Adjustable height shelf on each side -20 Removable microscope dividers	-Four concealed drawers -Pullout Pegboard with 50 assorted Pegs
Dimensions	Overall 28"W x 48"L x 36.25"H	Overall 28"W x 48"L x 36.25"H	Overall 28"W x 48"L x 36.25"H	Overall 28"W x 48"L x 36.25"H Trays 12.5"W x 17"L x 3"H	Overall 28"W x 48"L x 41.5"H	Overall 28"W x 48"L x 36.25"H
Doors	Two doors with Five-knuckle wrap-around hinges	Two doors with Five-knuckle wrap-around hinges	Two doors with Five-knuckle wrap-around hinges	Two doors with Five-knuckle wrap-around hinges	Four doors with Five-knuckle wrap-around hinges	Two doors with Five-knuckle wrap-around hinges
Lock System	Door	Door	Door and drawers	Door	Door (both sides)	Door
Weight	160 Lbs	155 Lbs	170 Lbs	165 Lbs	150 Lbs	155 Lbs
Tabletop	Chem-res Particleboard Core Black Pvc Edge Banding 1" Thick or Solid Phenolic Designer Beveled Edges .75" Thick					
Color	Standard: Oak Veneer - Custom: TFL Custom Colors Optoons					
Powerstrip	10-Outlet + 4 USB Input Surge Protected Power Strip, 15ft Cord, and Built-in Hook	10-Outlet + 4 USB Input Surge Protected Power Strip, 15ft Cord, and Built-in Hook	10-Outlet + 4 USB Input Surge Protected Power Strip, 15ft Cord, and Built-in Hook	-	-	10-Outlet + 4 USB Input Surge Protected Power Strip, 15ft Cord, and Built-in Hook
Ganging	Built-in Magnetic Ganging	Built-in Magnetic Ganging	Built-in Magnetic Ganging	Built-in Magnetic Ganging	Built-in Magnetic Ganging <i>(will only gang to other microscope carts)</i>	Built-in Magnetic Ganging
Casters	4 Swivel Casters, 2 Locking					
Sink	Optional Stainless Steel Sink with a Hand Pump Faucet, Two jugs included	Optional Stainless Steel Sink with a Hand Pump Faucet, Two jugs included	Optional Stainless Steel Sink with a Hand Pump Faucet, Two jugs included	-	-	Optional Stainless Steel Sink with a Hand Pump Faucet, Two jugs included
Whiteboard/Mirror	Optional Dual purpose: Whiteboard & Mirror framed in solid wood	Optional Dual purpose: Whiteboard & Mirror framed in solid wood	Optional Dual purpose: Whiteboard & Mirror framed in solid wood	-	-	Optional Dual purpose: Whiteboard & Mirror framed in solid wood

Looking for a Basic Storage Cart?

See our Model MSC2436

Ships Unassembled

Dimensions

Overall	24"W x 36"L x 36"H
Product Weight	103 lbs



Features



One Adjustable Height Shelf



1 1/4" Thick High Pressure Laminated Surface, Compliant With NEMA Standard Testing

SCIENCE WORKSTATION



*Empower Your Team's
Potential with the NPS
Hexagon Workstation*

Empower your students, enhance their learning experience, and create a more engaging classroom environment with the NPS Science Workstation.

This dynamic workstation comfortably accommodates 6 students around it. What sets Science Workstation apart is its thoughtful design maximizing the workstation capacity while also ensuring that every student has easy access to electricity with strategically placed outlet plugs.

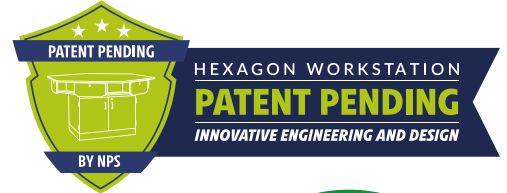

6 STATIONS
With full access to all features



MODERN DESIGN
Modern Two-Tone Black Edge and Hardware on Oak Panel Look



BUILT-IN EXTRA STORAGE
For personal/working elements

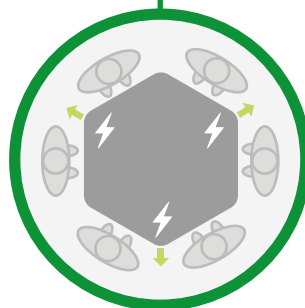

3 EXTERNAL POWERS HUBS
For uninterrupted connectivity

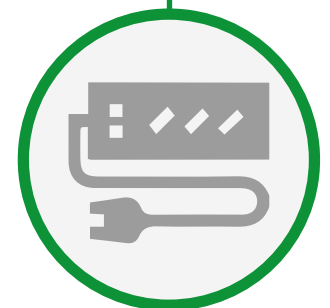

INTERNAL POWER HUB
For easy setup

Drawers

CODE: D

-OR-

Book Boxes

CODE: B



6 Plywood Core Drawers with an Ergonomically Carved Handle Design. Drawers Lock To Keep Contents Safe



6 Book Boxes for Open Storage with Easy Accessibility. Inner Dimensions 15.75" W x 11" D x 4.5"H



Doors Lock To Keep Contents Safe

One Adjustable Height Shelf

Optionally Installed Rubber Toe Kick to Protect Against Spills or Damages

Doors Feature Five-knuckle Wrap-Around Hinges

Add-Ons



2 Gas+Cold Water Fixtures

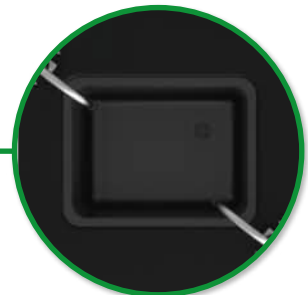

Black Epoxy Resin Sink
 with Drain, Sink Outlet and Stopper

(Available with Phenolic or Epoxy Tabletop)



Internal Power Hub

10-Outlet + 4 USB Input Surge
 Protected Power Strip with a 15ft Cord



3 UL Approved Powers Hubs

Each Power Hub is Rated at 125v, 60Hz, 15A, and Offers the Following Features:

- Two Tamper-Resistant AC Outlets
- One USB Type-A charging port delivering 5V at 2.1A (10.5W)
- One USB Type-C charging port providing 5V at 2.4A (12W)
- Built-in 10-foot power cord (14 AWG x 3C) that is routed to the power strip inside the cabinet.

Tabletops



Chem-Res
 1" Particleboard Core
 Chemical Resistant Top
 Edge Banding
 (C)



Phenolic
 .75" Solid Phenolic
 Designer Beveled Edges
 (P)



Epoxy
 1" Solid Epoxy
 Designer Beveled Edges
 (E)

Add-Ons Description

S	Standard
P	Built-In Power Hubs
ESFG	Epoxy Sink & Gas-Water Fixtures

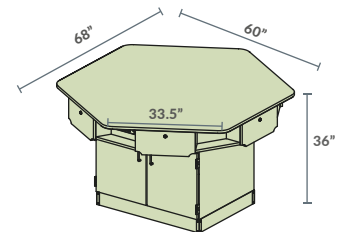

Base Design



Cabinet
 (C)

Apron Style Options



Drawers
 (D)



Book Boxes
 (B)

Model Number Configuration



SCIENCE TABLES | SLT SERIES
Solid Wood Tables



Tabletops



High Pressure Laminate
 1.2" Particleboard Core
 Black HPL Surface | T-molding
 (H)



Chem-Res
 1" Particleboard Core
 Chemical Resistant Top
 Edge Banding
 (C)



Phenolic
 .75" Solid Phenolic
 Designer Beveled Edges
 (P)



Whiteboard
 1.2" Particleboard Core
 Markerboard HPL Surface
 PVC Edge Banding
 (W)



Epoxy
 1" Solid Epoxy Resin
 Designer Beveled Edges
 (E)



Trespa
 .75" Cellulose Core
 Designer Beveled Edges
 (T)



SCIENCE TABLES | SLT SERIES

Solid Wood Science Tables



Features



Rubber Boots
Protect Against Spills

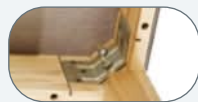

Legs Attach W/ Metal
on Metal Double Bolt
Assembly on 13-Gauge
Steel Corner Braces



2 1/4" Thick Solid Ash
Square Legs



Adjustable Glides
for Accurate Floor
Leveling



Available
With Book
Compartments



Optional Heavy Duty
3" Thermoplastic Rubber
Casters with a side lock and
Stretchers and Braces

Model Number Configuration

Model Number Size Add-Ons

SLT1 - 2448 H BC

Top Material

Size (width/Length in inches)

2430 2448 2454 2460 2472

3030 3060 3072 4260 4272

● Lightning ship tables available, choose from tops H, C and P

● Lightning ship tables available with top C only

Standard lead time is 8 weeks.

Lightning ship lead time is 2 days.

Top Description

W	Whiteboard
H	Black High-Pressure Laminate
C	Chem-Res
P	Phenolic
E	Epoxy
T	Trespa

Using Epoxy tables in mobile applications with casters voids the warranty.

Add-on Description

B	Add Book Boxes
C	Add Casters* & Stretchers

*Additional 3.5" Height with Casters

Model# Description

SLT1	30" High*, Science Lab Table, Wood Frame
SLT2	36" High*, Science Lab Table, Wood Frame

*Additional 3.5" Height when ordered with Casters

All tables wider than 30", longer than 72", or with Epoxy tabletop will include stretchers and braces



products meet or exceed applicable ANSI/BIFMA standards



www.nationalpublicseating.com | National Public Seating®



SCIENCE TABLES | SLT SERIES

Steel Science Tables

Tabletops



High Pressure Laminate
1.2" Particleboard Core
Black HPL Surface | T-molding
(H)



Chem-Res
1" Particleboard Core
Chemical Resistant Top
Edge Banding
(C)



Phenolic
.75" Solid Phenolic
Designer Beveled Edges
(P)



Epoxy
1" Solid Epoxy Resin
Designer Beveled Edges
(E)



Trespa
.75" Cellulose Core
Designer Beveled Edges
(T)



Features



Corner Brackets
Bolted Onto Frame



Welded 12-Gauge
Leg Top Plate



11-Gauge Welded
Support Brackets



Leveling Glides Can Add
up to 3/4" Height to Table



Dual-Side Leg
Connection



Adjustable Legs
Adjust in 1"
Increments



16-Gauge
Channel Frame



Optional Heavy-Duty
3" Thermoplastic Rubber
Casters with a side lock and
Gussets Available



Color Options



Black



Soft Grey

Model Number Configuration

Model Number Size Top Material
SLT3 - 2448 H

Model# Description

SLT3	Height adjustable steel table, black
SLT7	Fixed Height steel table, black
SLT8	Height adjustable steel table, soft grey
SLT9	Fixed Height steel table, soft grey

Size (Width/Length in inches)

2430	2448	2454	2460	2472
3030	3060	3072		
4248	4260	4272		

● Lightning ship tables available, choose from tops H, C and P
 ● Lightning ship tables available with top C only
 Standard lead time is 8 weeks. Quick ship lead time is 7 days.

Top Description

H	Black High-Pressure Laminate
C	Chem-Res
P	Phenolic
E	Epoxy
T	Trespa

Using Epoxy tables in mobile applications with casters voids the warranty.

Caster/Gusset Model

Model Number Frame Number
 (of table that it will be used with - i.e. #SLT3)
CAST-3



Without Casters



With Casters



products meet or exceed applicable ANSI/BIFMA standards



Compliant with Adjustable Legs



SCIENCE TABLES | SLT SERIES

Steel Designer Science Tables

Tabletops



Chem-Res
1" Particleboard Core
Chemical Resistant Top
Edge Banding
(C)



Phenolic
.75" Solid Phenolic
Designer Beveled Edges
(P)



Epoxy
1" Solid Epoxy Resin
Designer Beveled Edges
(E)



Trespa
.75" Cellulose Core
Designer Beveled Edges
(T)



*Innovative
Designer Apron*

i For more specs
see **Page 89**

Size (Width/Length in inches)

1824	1830	1836	1842	1848	1854	1860	1872	1884	1896
2424	2430	2436	2442	2448	2454	2460	2472	2484	2496
3030	3036	3042	3048	3054	3060	3072	3084	3096	
3636	3642	3648	3654	3660	3672	3684	3696		
4242	4248	4254	4260	4272	4284	4296			
4848	4854	4860	4872	4884	4896				

● Quick ship tables available, choose from tops P and C

● Quick ship tables available with top C only

Standard lead time is 8 weeks. Quick ship lead time is 7 days.

Model#	Description
● SLTD3	Height adjustable steel table, black
● SLTD7	Fixed Height steel table, black
● SLTD8	Height adjustable steel table, soft grey
● SLTD9	Fixed Height steel table, soft grey

Model Number Configuration

Model Number Size Top Material
SLTD3 - 2448 C



Steel Activity Science Tables

Shapes



Trapezoid
(TZ)



Tri
(TR)



Square
(SQ)



Semicircle
(SC)



Hexa
(HX)



Round
(RD)



More Shapes and Sizes on **Page 266**



i For more specs
see **Page 93**



Tabletops



Chem-Res
1" Particleboard Core
Chemical Resistant Top
Edge Banding
(C)

Model#	Description
SLTA3	Height adjustable steel table, black
SLTA7	Fixed Height steel table, black
SLTA8	Height adjustable steel table, soft grey
SLTA9	Fixed Height steel table, soft grey

Model Number Configuration

Model Number Size Top Material
SLTA7 - TZ 2448 C
 Shape



Aero-Lift Tables

WOOD FRAME TABLE



 For product details see **Page 102**

ACTIVITY TABLE



Versatile Bracket,
Perfect for Any Table Shape

25+ Shapes to choose from
See Page 266



 For product details see **Page 105**

*Effortless Elevation, Endless Possibilities:
Experience the Aero-lift Table's Precision
and Versatility at Every Height.*



STEEL FRAME TABLE

STEEL DESIGNER FRAME TABLE

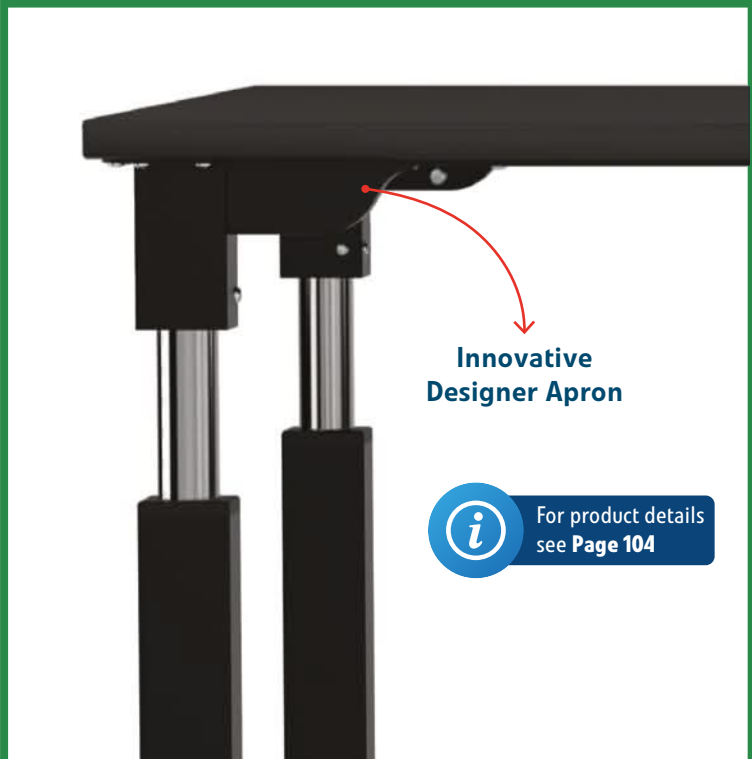

SIGNATURE TABLE

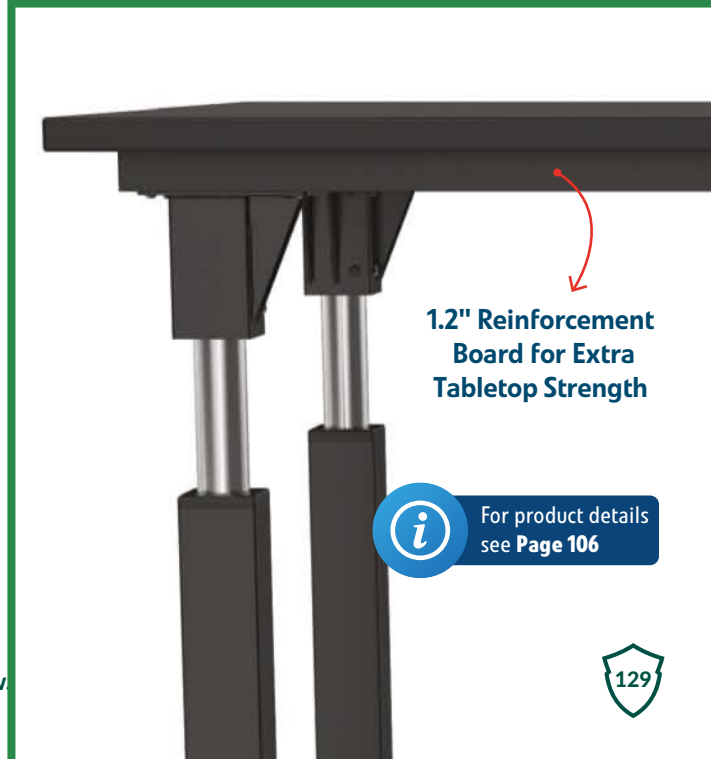

Solutions for Every CTE Pathway

Scan or
Click Here to
Explore More!



AUDIO/VISUAL PRODUCTION

#Activity Tables → Page 90
#Comfort Task Chairs → Page 46



ROBOTICS & ENGINEERING

#Titan Tables → Page 80 #Titan Stools → Page 44
#Table Bumper Kit → Page 96



ESPORTS

#Aero-Lift Activity Tables → Page 105
#Comfort Task Chairs → Page 46



HEALTHCARE

#Treatment Tables → Page 132 #Mobile Flipper Tables
→ Page 74 #ROBO Dividers → Page 199



CULINARY ARTS

#Heavy-Duty Tables → Page 82
#Titan Stools → Page 44



CARPENTRY

#Heavy-Duty Tables → Page 82
#Pegboards → Page 89 #Titan Stools → Page 44



AVIATION

#Science Lab Tables → Page 126 #6800 Stools
→ Page 42 #Plastic Folding Tables → Page 53



DRONE TECH

#Air-Lift Nesting Cafe Table → Page 182
#Max Seating Folding Tables → Page 70



AUTOMOTIVE

#Titan Tables → Page 80 #Titan Stools → Page 44
#Mobile Carts → Page 110



PHOTOGRAPHY

#Presentation Carts → Page 242
#Duet Charging Cart → Page 244

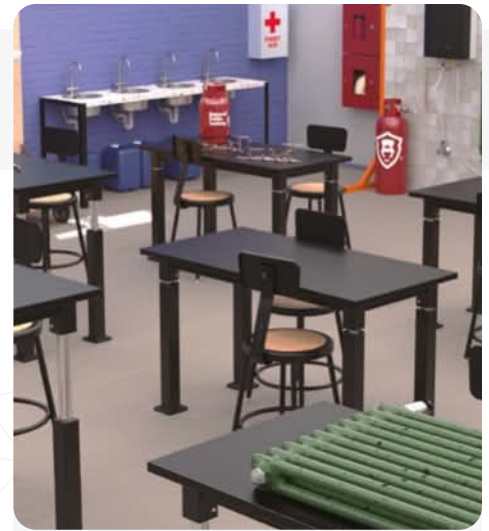

PLUMBING

#Steel Frame /Aero-Lift Tables → Page 103
#Heavy-Duty Stools → Page 38



HVAC

#Wood Science Tables → Page 124
#Heavy-Duty Stools → Page 38



WELDING

#Box Top Welding Tables → Page 56
#Flat Top Welding Tables → Page 13



CULINARY ARTS

#Heavy-Duty Tables With Stainless Steel
Tabletops → Page 82



DENTAL

#Hexagon Workstations → Page 121 #ROBO
Dividers → Page 199 #Activity Tables → Page 91



LOCKSMITH

#Titan Tables → Page 80 #Mobile Carts → Page 110
#Heavy-Duty Stools → Page 38 #Tote Trays → Page 95



COSMETOLOGY

#Café Tables → Page 180 #Z-Stools → Page 43
#Collaborator Tables → Page 187



Look for this icon throughout our catalog to find our recommended furniture for CTE spaces.

Treatment Tables



*Where Education Meets
Real-Life Practice.*

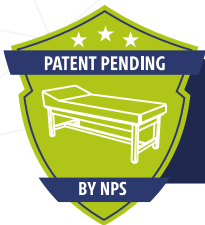

TREATMENT TABLE
PATENT PENDING
INNOVATIVE ENGINEERING AND DESIGN



Configured to Perform

Choose **WOOD FRAME**
or **STEEL FRAME**



CTE SOLUTIONS | PBRT SERIES
Treatment Tables



Wood Frame



Features



2 ¼" Thick Solid Ash Square Leg

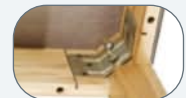

Legs Attach W/ Metal on Metal Double Bolt Assembly on 13-Gauge Steel Corner Braces



Adjustable Glides For Accurate Leveling



Stretchers And Braces For Added Strength

Features



Corner Brackets Bolted Onto 16-Gauge Channel Frame



Dual-Side Leg Connection



Welded 12-Gauge Leg Top Plate



11-Gauge Welded Support Brackets



Leveling Glides Can Add up to 3/4" Height to Table



Legs Built with 1-1/2" Square Tubing 14 Gauge Thickness

Steel Frame



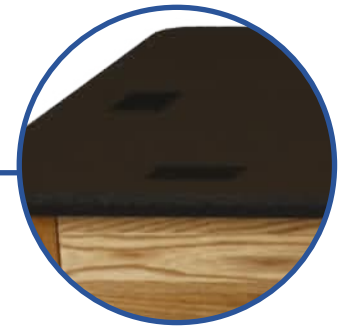
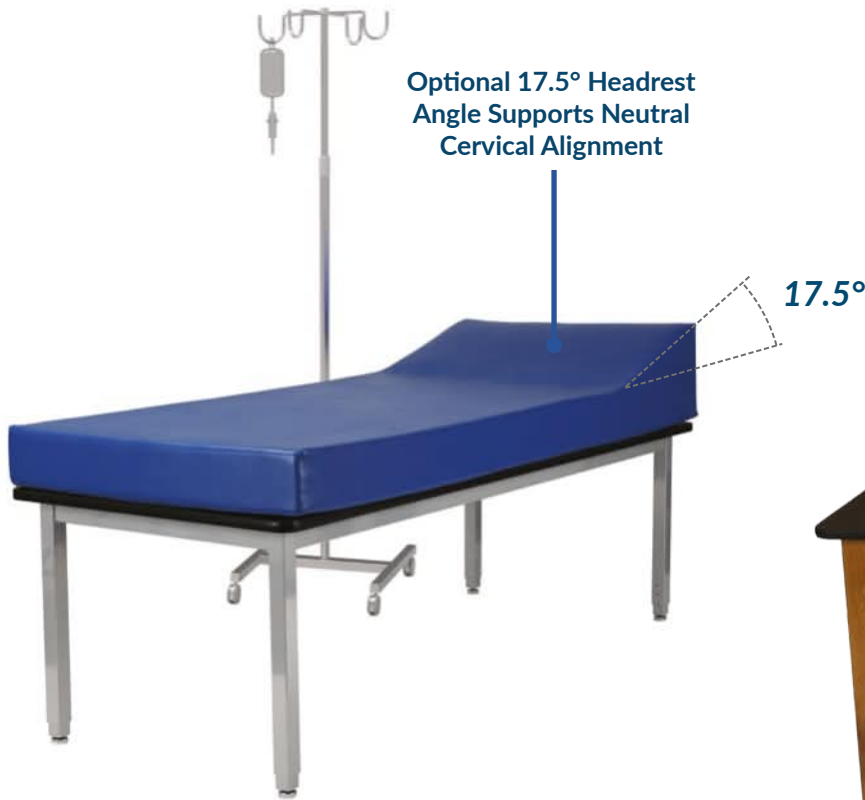

8 Velcro Straps for Easy Mattress Installation



Use the table as a work surface by removing the mattress.

Frame Style Options



Wood Frame (WA)



Steel Frame

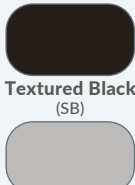

Textured Black (SB)
Soft Grey (SG)

Mattress Style Options



Flat Mattress (F)



Mattress w/ Built-in Headrest (H)

Colors

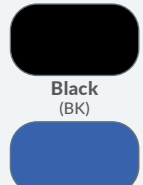

Black (BK)



Blue (BL)

Shared Features



Worksurface Is .75" Thick Plywood Core With Black HPL Surface And 3mm Hot-Melt PVC Edge



5" Thick High-Density Foam Mattress Upholstered In Vinyl

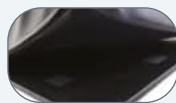

Mattress is installed with Velcro, making it easy to remove for cleaning



Mattress Includes A Zipper For Easy Cover Removal And Cleaning



Model Number Configuration

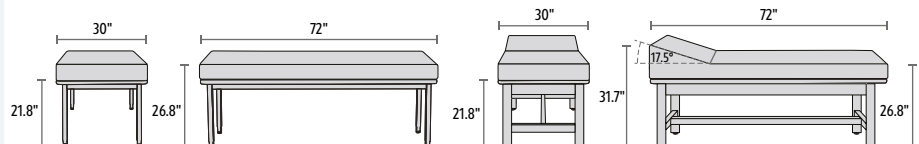

NEW

Practical Welding Starts Strong with NPS.

AVAILABLE
→ **SUMMER 2026**

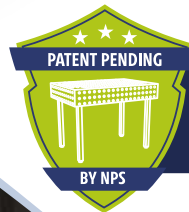

WELDING TABLE
PATENT PENDING
INNOVATIVE ENGINEERING AND DESIGN



Welding Tables



Modular Design. Maximum Flexibility.

Join Tables to Build Custom Workspaces of Any Size.



*Designed for full compatibility
with most industry-standard
6 mm and 5/8" fixturing kits.*



Welding Tables

2 Top Styles Options

FLAT TOP

BOX TOP

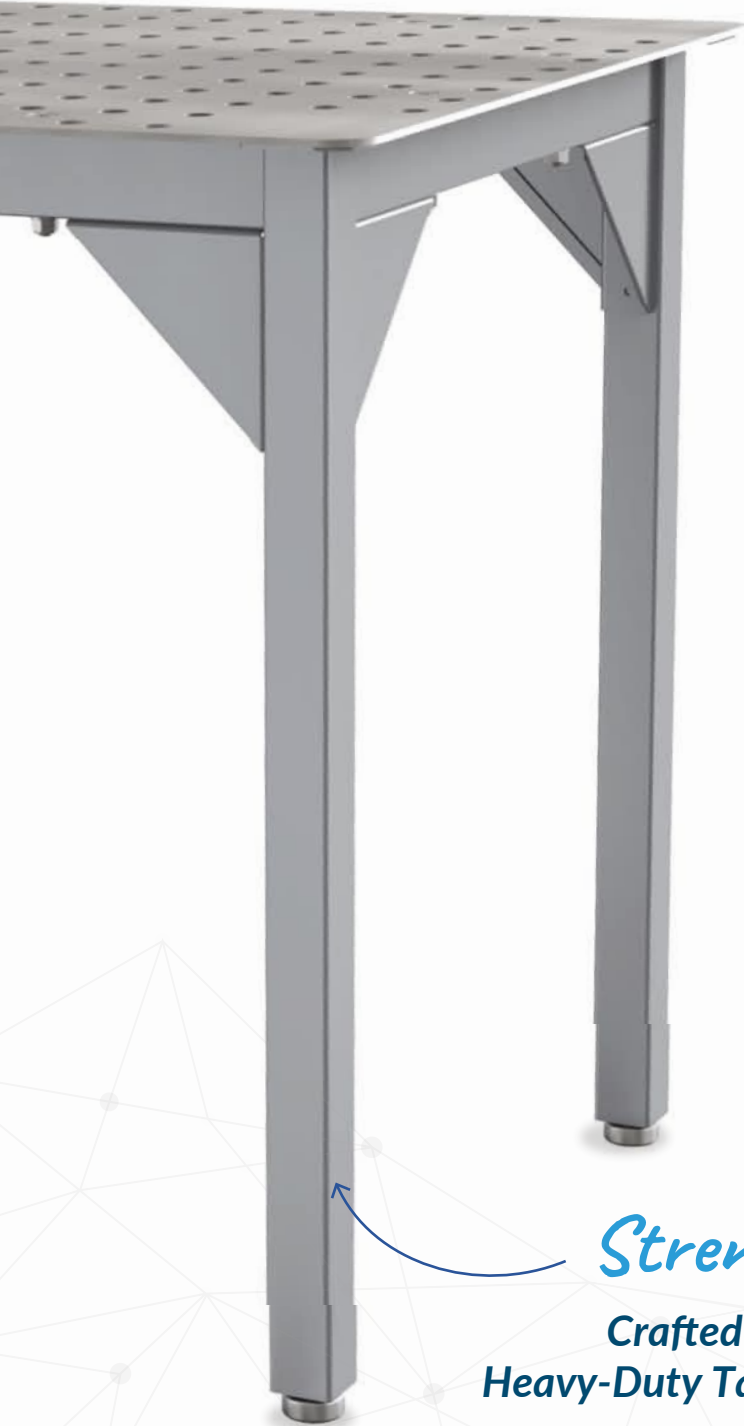

Strength you know

**Crafted With Our Signature
Heavy-Duty Table Frame And Leg System**

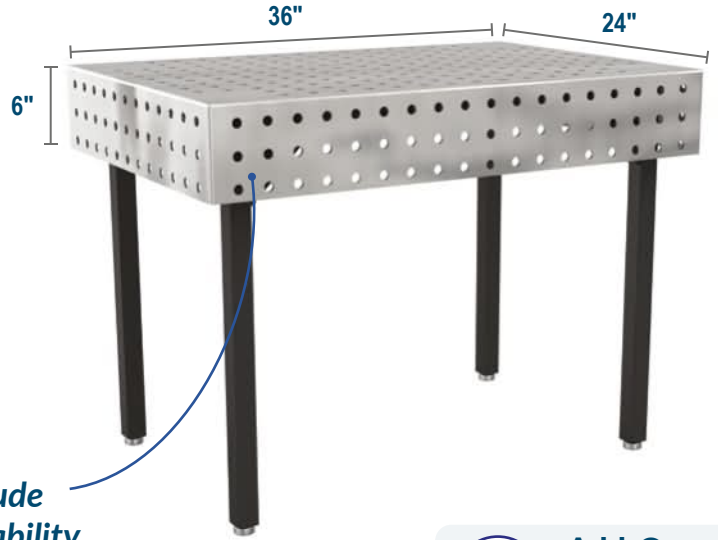
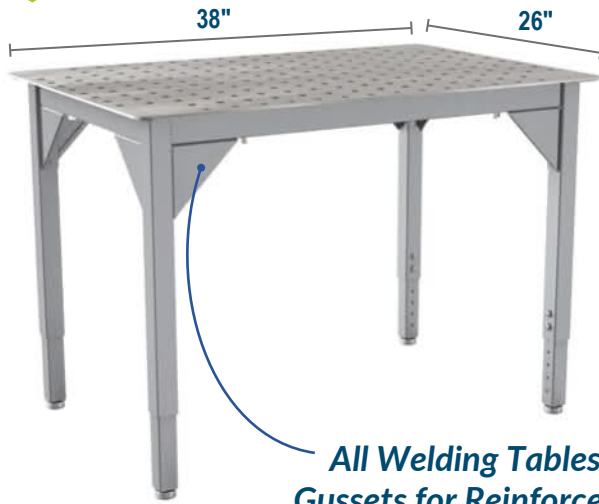
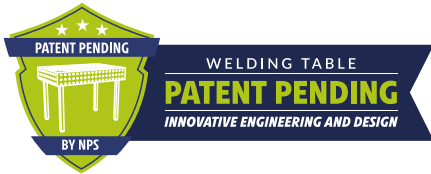

All Welding Tables Include Gussets for Reinforced Stability

Add-Ons
 Optional Caster Kit Available

Top Styles



26"W x 38"L x 6"H
Box Top
 (Code: 2638B)



24"W x 36"L x 4mm H
Flat Top
 (Code: 2436F)

Frame Colors



Textured Black

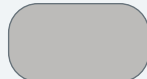

Soft Grey

Leg Construction

Fixed Height Legs:



Adjustable Height Legs:



Tabletop Shared Features

See Back for Stainless Steel Care Instructions



Heavy-Duty Top
 Constructed from 4mm
 Thick Stainless Steel



Built from
 High-Quality
 304 Stainless Steel



Standard 16 mm Hole
 Size with 2" Pattern for
 Tool Compatibility



Full Welded Frame
 with Center Cross Bar

Frame#	Description
WLT3	Heavy-Duty Frame, Height Adjustable, Textured Black
WLT7	Heavy-Duty Frame, Fixed Height Legs, Textured Black
WLT8	Heavy-Duty Frame, Height Adjustable, Soft Grey
WLT9	Heavy-Duty Frame, Fixed Height Legs, Soft Grey

Frame Features



Corner Brackets
 Bolted Onto Frame



Dual-Side Leg
 Connection



Welded 12-Gauge
 Leg Top Plate



Adjustable Legs
 Adjust in 1"
 Increments



11-Gauge Welded
 Support Brackets



16-Gauge
 Channel Frame



Leveling Glides
 Can Add up to 3/4"
 Height to Table



Legs Built with
 1-1/2" Square Tubing
 14 Gauge Thickness

Model Number Configuration

Frame# Top Style Code
WLD3-2638B



WORKSTATIONS

**Sit Stand
Desks**
EDTC



Workstations
Teacher's EduPod
Teacher's WorkPod



WORKSTATIONS | EDTC SERIES
Sit Stand Students Desk



1-2 DAY LIGHTNING SHIP

WEIGHT CAPACITY
 250 lbs

ten year warranty
10

TAA ✓

Features



Strong Powder-Coated Steel Frame



2 1/2" Two-Tone Double-Wheel Hooded Casters



Pneumatic Adjusting System

Model Number
EDTC

Color

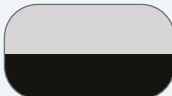

Speckled Grey Surface
 Black Steel Frame

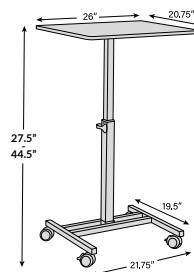

Description

Description	Dimensions
Top Shelf Dimensions	26" L x 20.75" D
Height Adjustable	27.75" - 44.5"
Leg Dimensions	21.75" L x 19.5" D
Unit Weight	35 lbs.



WORKSTATIONS | EDPD SERIES
Edupod Teacher's Desk & Lectern



Features



Beautiful Blow-Molded Table Top



3 Shelves, 2 Adjustable for Customizability

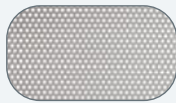

Built-in Perforated Modesty Panel



Locking Storage Cabinet for Security



Wire Management Grommet for Technology Equipment



6 Hooded Twin-Wheel, Two-Inch Casters, 3 Lock for Stability

Colors

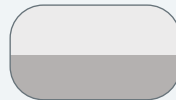

Speckled Grey Tabletop
 Grey Hammer Tone Cabinet and Frame

Model Number

EDPD

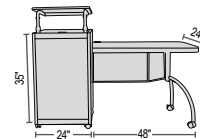

Description

Dimensions

Overall Dimensions	68"L x 24"W
Desk Dimensions	48"L x 24"W
Desk Thickness	2-inch
Cabinet Dimensions (including casters)	24"L x 20"W x 28.5"H
Lectern Desk	24"L x 20"W x 28.5"H
Lectern Thickness	3/4-inch
Cabinet Shelves Dimensions	19"L x 22"W
Unit Weight	115 lbs.



Colors



Charcoal Slate and Black

Features



Double Frame for Added Support



Desk Can Be Hooked on to Either Side of the Lectern



Unhook the Desk from the Lectern to Use Separately



Built-in Attractive Mesh Front Provides Venting to Prevent Overheating



Contemporary Frame and Legs



Adjustable Height Surface with Metal Bookstop

Model# Description

TWPD	Teacher's WorkPod Desk
TWPL	Teacher's WorkPod Lectern
TWP	Teacher's WorkPod Desk & Lectern Kit

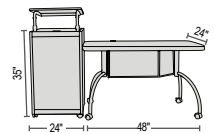

Description

Dimensions

Overall Dimensions	68" L x 24" W
Desk Dimensions	48" L x 24" W
Desk Thickness	2-inch
Cabinet Dimensions (including casters)	24" L x 20" W x 35" H
Lectern Desk	24" L x 20" W
Lectern Thickness	3/4-inch
Cabinet Shelves Dimensions	19" L x 22" W
Unit Weight	115 lbs.
Lectern Portion Weight	85 lbs.





Our tables come in

Rectangle



Square



Hexagon



Octagon



all shapes and sizes

Round



Oval



Elliptical



>>>>>>
SEE NEXT PAGE FOR
**DESIGNER
SHAPES**
>>>>>>

Designer

Swerve Table

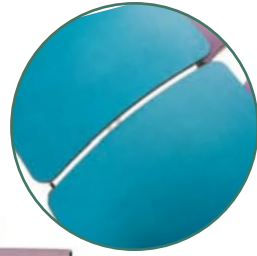

Shapes

Bedrock Table



Table & Bench Core Options



3/4" MDF (MD)



3/4" Particleboard (PB)



3/4" Plywood (PW)

Frame Color Options



Chrome (CR)



Black Powder Coating (PC)

Table/Seat Heights*

25"/13"***
code: 25

27"/15"
code: 27

29"/17"
standard‡

32"/20"
code: 32

*For non-standard heights add code to end of model number

**For Round and Octogon Shapes is 25"/15"

‡Standard MTS1216 is 27"/15"

Mobile Table Features Stool, Bench, Shape, and Combo Units



Casters Lift off Floor to Prevent Table from Moving When Opened



Tamper-Free, Non-Marring, Nylon Steel-Insert Glides and Tube Closures



Protect Edge Option Prevents Food from Being Trapped Between the Laminate and Edge

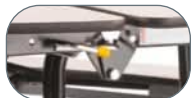

Self-Leveling Automatic Down Lock Ensures Engagement Every Time Table Is Fully Opened



Locks Table Partially Open for Easy Floor Cleaning



No Need to Reach in! Storage Latch Release Handles on Both Sides of Table to Unlock. Locks Automatically When Folded



4" Double Ball Bearing Non-Marring Heavy-Duty Casters With 275 Lb. Weight Capacity Ea



"EasyLift" Torsion Bar System. One Person Can Easily Lift and Fold Table for Convenient Storage



14-Gauge Steel Framing

Bench Features



Prevent Tripping During Entry With Our Exclusive Curved Frame Design



3/4" Thick Benches Reinforced With 16-Gauge Aprons

Stool Features



High Impact Stools Reinforced With Embedded Steel Washers



Hex-Head Serrated Flange Bolts & Serrated Flange Nylon Insert Nuts Provides Stronger and Simpler Assembly

Easy Fold Features



One-Piece Top Eliminates the Gap in the Middle of Surface



4" Double Ball Bearing Non-Marring Heavy-Duty Casters With 275 Lb. Weight Capacity Ea



Casters Lift off Floor to Prevent Table from Moving When Opened



Gas Spring Rated to 100,000 Cycles Balances Open-Fold Operation - Simple for One Person Operation



Automatically Locks Open With Two Points of Manual Release to Fold

Convertible Bench Features



Create One Large Table By Combining Single Units



Non-Marring Reinforced Nylon Glides With Steel



"Pinch-Proof" Feature: Bench



Under Table Hat Supports 1000 Lb. Weight



Easy Lock 3" Double Ball-Bearing Casters

PAGE 255 | Laminate, Edge, and Stool Options





*Customize your Laminate
with a Design Inspired
by YOUR LOGO*

JUST SEND US A LOGO FILE!





Shape Tables

*Mobile tables that
shape up to your unique
seating needs.*



MOBILE TABLE FRAME
PATENTED
INNOVATIVE ENGINEERING AND DESIGN

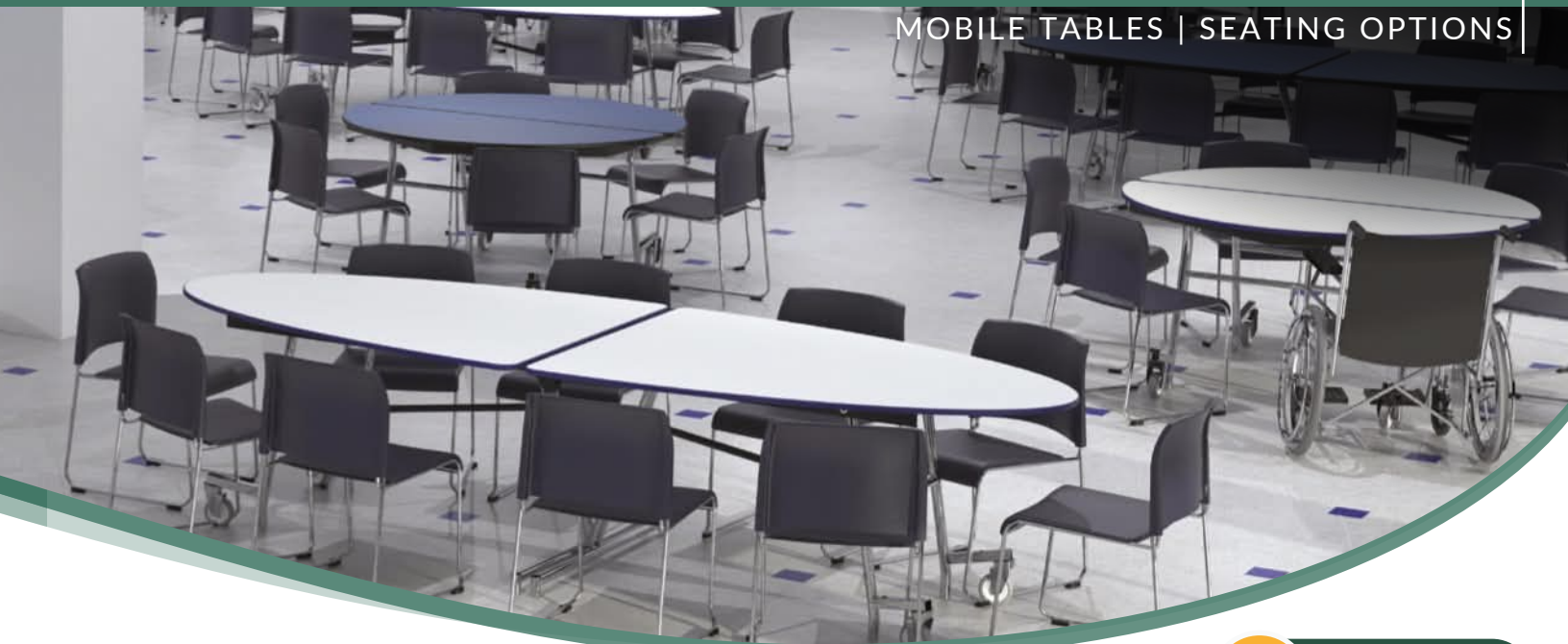

See Page 150 for Product Features



New! Choose from 3 laminate options
(Just replace "xx" with Laminate code)

- Grey Nebula
GY
- Montana Walnut
WT
- Fusion Maple
FM

MT12-MDPEPCxx | MT12-MDPECRxx
(12' Rectangle, MDF/ProtectEdge, Textured Black or Chrome Frame, HPL Top)

MT60R-MDPEPCxx | MT60R-MDPECRxx
(60" Round, MDF/ProtectEdge, Textured Black or Chrome Frame, HPL Top)

Shapes

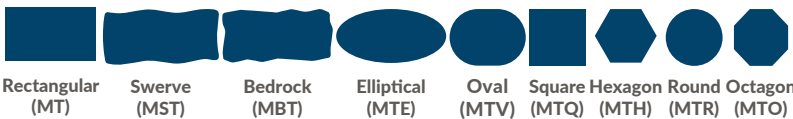

Model #	Shape	Open (WxLxH) Dimensions	Folded (WxLxH) Dimensions	Table Height (Custom)
MT8	Rectangular	30"x97"x29"	30"x32½"x60"	25"
MT10	Rectangular	30"x120½"x29"	30"x33½"x68"	
MT12	Rectangular	30"x145"x29"	30"x34¾"x80¾"	
MST8	Swerve	29"x97½"x29"	29"x32½"x60"	27"
MST10	Swerve	29"x121½"x29"	29"x33½"x68"	
MST12	Swerve	29"x145¼"x29"	29"x34¾"x80¾"	
MBT8	Bedrock	29½"x99"x29"	29½"x32½"x60"	32"
MBT10	Bedrock	29½"x123"x29"	29½"x33¾"x67¾"	
MBT12	Bedrock	29½"x145"x29"	29½"x34¾"x80¾"	
MTE10	Elliptical	45"x121"x29"	45"x36½"x67½"	25"
MT72V	Oval	60¾"x72"x29"	60¾"x19¾"x45¼"	
MT48Q	Square	48"x48"x29"	48"x20"x39¾"	
MT60Q	Square	60"x60"x29"	60"x19¾"x43"	27"
MT48H	Hexagon	48"x54½"x29"	48"x19½"x39¾"	
MT48R	Round	48"x48"x29"	48"x20"x39¾"	
MT60R	Round	60"x60"x29"	60"x19½"x43"	32"
MT72R	Round	71¾"x71¾"x29"	71¾"x20"x45¼"	
MT60O	Octagon	62¾"x64½"x29"	62¾"x19½"x43"	

Model Number Configuration

Model # Core Edge Frame Laminate Color Top

MTE10-MD PE CR CH

Add custom height to the end of model number

ADA Configurations

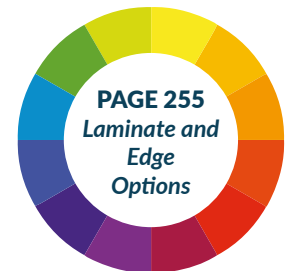
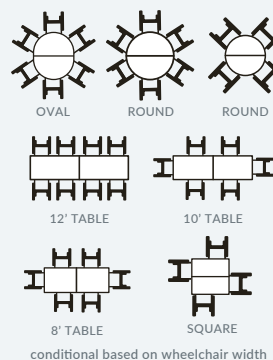

Bench Tables

Better together! Bench tables make group seating simple.



MOBILE TABLE FRAME
PATENTED
INNOVATIVE ENGINEERING AND DESIGN



See Page 150 for Product Features



7 DAY QUICK SHIP

New! Choose from 3 laminate options (Replace "xx" with one laminate code. The same laminate will be used on the tabletop and benches)

MTFB12-MDPEPC xx xx | MTFB12-MDPECRxx xx
 (12' Rectangle, MDF/ProtectEdge, Textured Black or Chrome Frame, HPL Top & Benches)
MTR60B-MDPEPCxx xx | MTR60B-MDPECRxx xx
 (60" Round, MDF/ProtectEdge, Textured Black or Chrome Frame, HPL Top & Benches)

-  Grey Nebula GY
-  Fusion Maple FM
-  Montana Walnut WT

Shapes



Model Number Configuration

Model # Core Edge Frame Tabletop Laminate
MTFB12-MD PE CR CH GY
 Add custom height and/or ADA code to the end of model number Bench Laminate

Model #	Shape	Seats	Open (WxLxH) Dimensions	Seat Height (Standard)	Folded (WxLxH) Dimensions	Table/Seat Height (Custom)	
MTFB8	Rectangular	8-12	56½"x96"x29"	17"	56½"x27¾"x60¾"	25"-13" 27"-15" 32"-20"	
MTFB10	Rectangular	10-14	56½"x120¾"x29"	17"	56½"x33¾"x68¼"		
MTFB12	Rectangular	12-16	56½"x145"x29"	17"	56½"x34"x81¼"		
MSTB8	Swerve	8-12	57¼"x97½"x29"	17"	57¼"x29¾"x60¼"		
MSTB10	Swerve	10-14	57¼"x121½"x29"	17"	57¼"x33¾"x68¾"		
MSTB12	Swerve	12-16	57¼"x145"x29"	17"	57¼"x34"x81¼"		
MBTB8	Bedrock	8-10	58¾"x99"x29"	17"	58¾"x28¾"x60¾"		
MBTB10	Bedrock	10-12	58¾"x123"x29"	17"	58¾"x33¾"x68¾"		
MBTB12	Bedrock	12-16	58¾"x146¾"x29"	17"	58¾"x34"x81¼"		
METB	Elliptical	10-12	71¾"x121"x29"	17"	71¾"x38"x73¾"		
MTR60B	Round	8	84"x83¾"x29"	17"	84"x36¾"x53"		25"-15" 27"-15" 32"-20"
MTO60B	Octagon	8	84"x83¾"x29"	17"	84"x36¾"x53"		

ADA Configurations

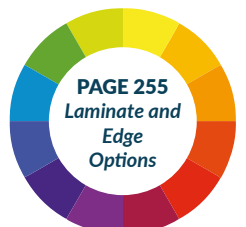
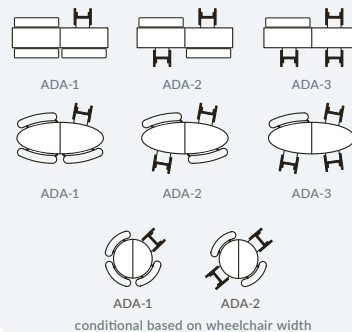



Stool Tables

*Roll in, roll out, flip,
and store. Pairs well
with any seating!*

TWO STOOL SHAPES AVAILABLE



Round Stool



ErgoMax Stool



MOBILE TABLE FRAME
PATENTED
INNOVATIVE ENGINEERING AND DESIGN



ERGOMAX STOOL
PATENTED
INNOVATIVE ENGINEERING AND DESIGN





See Page 150 for Product Features

Shapes



Model #	Shape	Seats	Open (WxLxH) Dimensions	Seat Height (Standard)	Folded (WxLxH) Dimensions	Table/Seat Height (Custom)
MTS8	Rectangular	8	59½"x97"x29"	17"	59½"x39¼"x56½"	25"-13" 27"-15"
MTS10	Rectangular	12	59½"x120¾"x29"	17"	59½"x41½"x72¾"	
MTS12	Rectangular	12	59½"x145"x29"	17"	59½"x40"x80"	
MTS1316*	Rectangular	16	59½"x157"x29"	17"	59½"x 37"x 91¼"	25"-13" 27"-15"
MSTS8	Swerve	8	59½"x97½"x29"	17"	59½"x39"x56½"	
MSTS10	Swerve	12	59½"x121½"x29"	17"	59½"x40½"x73"	
MSTS12	Swerve	12	59½"x145¼"x29"	17"	59½"x40"x80"	25"-13" 27"-15"
MTS1316*	Swerve	16	59½"x157½"x29"	17"	59½"x 37"x 91¼"	
MBTS8	Bedrock	8	59½"x99"x29"	17"	59½"x39¼"x56½"	
MBTS10	Bedrock	12	59½"x123"x29"	17"	59½"x41½"x72¾"	25"-13" 27"-15"
MBTS12	Bedrock	12	59½"x146¾"x29"	17"	59½"x40"x80"	
MTB1316*	Bedrock	16	59½"x158"x29"	17"	59½"x 37"x 91¼"	
MTR60S	Round	8	82½"x76¼"x29"	17"	82½"x40"x53"	25"-15" 27"-15"
MTO60S	Octagon	8	82½"x60"x29"	17"	82½"x40¼"x53"	
METS	Elliptical	12	73¾"x121"x29"	17"	73¾"x42"x73"	25"-13" 27"-15"

*Custom SKU: Extra-tall 91" folded height, high doorway and special shipping requirements. Non-refundable/cancellable after order.

12-Foot Tables are available with 16 seats. Featuring Table Height of 27" and Seat Height 15" (Standard)

MTS1216	Rectangular	16	59½"x145"x27"	15"	59½"x37"x82½"	25"-13"
MSTS1216	Swerve	16	59½"x145¼"x27"	15"	59½"x37"x82½"	
MBTS1216	Bedrock	16	59½"x146¾"x27"	15"	59½"x37"x82½"	

7 DAY QUICK SHIP

Now! Choose from 3 laminate options (Just replace "xx" with Laminate code)

xx:Stool Color Code

MTS1216-MDPEPCxx xx | MTS1216-MDPECRxx xx
 (12' Rectangle, MDF/ProtectEdge, Textured Black or Chrome Frame, HPL Top)
 MTS12-MDPEPCxx xx | MTS12-MDPECRxx xx
 (12' Rectangle, MDF/ProtectEdge, Textured Black or Chrome Frame, HPL Top)
 MTR60S-MDPEPCxx xx | MTR60S-MDPECRxx xx
 (60" Round, MDF/ProtectEdge, Textured Black or Chrome Frame, HPL Top)

- Grey Nebula GY
- Montana Walnut WT
- Fusion Maple FM

Model Number Configuration

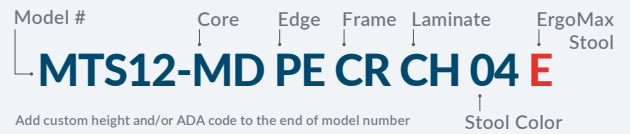

ADA Configurations

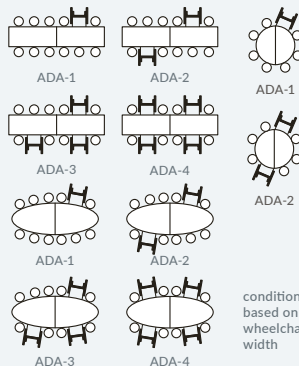

DESIGNED, ENGINEERED & ASSEMBLED IN THE U.S.A.
 WITH GLOBAL MATERIALS

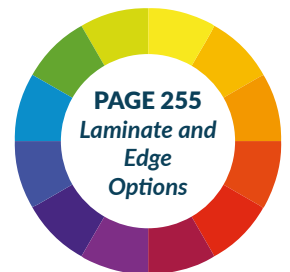



ComboTables

The best of both worlds - bench or stool, sit together how you'd like!



TWO STOOL SHAPES AVAILABLE



Round Stool



ErgoMax Stool



MOBILE TABLE FRAME

PATENTED

INNOVATIVE ENGINEERING AND DESIGN



ERGOMAX STOOL

PATENTED

INNOVATIVE ENGINEERING AND DESIGN



See Page 150 for Product Features



DESIGNED, ENGINEERED & ASSEMBLED IN THE U.S.A.
WITH GLOBAL MATERIALS

Shapes

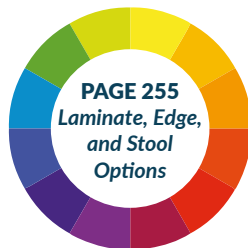

Model Number Configuration

Model # Core Edge Bench Laminate Stool Color
MTR60SB-MD PE CR XX XX XX E
 Add custom height and/or ADA code to the end of model number
 Frame Tabletop Laminate ErgoMax Stool

Model #	Shape	Seats	Open (WxLxH) Dimensions	Seat Height (Standard)	Folded (WxLxH) Dimensions	Table/Seat Height (Custom)
METSB	Elliptical	12	74"x121"x29"	17"	74"x39½"x73"	25"-13" 27"-15" 32"-20"
MTR60SB	Round	8	84"x83¼"x29"	17"	84"x40½"x53"	25"-15" 27"-15" 32"-20"
MTO60SB	Octagon	8	84"x83¼"x29"	17"	84"x40½"x53"	25"-15" 27"-15" 32"-20"

ADA Configurations

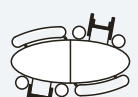
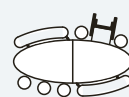

ADA-1

ADA-2

ADA-1

ADA-2

conditional based on wheelchair width

Easyfold Units

*Roll in, roll out, flip,
and store. Pairs well
with any seating!*





See Page 150 for Product Features



Shapes



Model #	Shape	Open (WxLxH) Dimensions	Folded (WxLxH) Dimensions	Table Height (Custom)
MTSSF-60V	Oval	60"x72"x29"	60"x20¼"x81¼"	25" 27" 32" 42"
MTSSF--48Q	Square	48"x48"x29"	48"x19¼"x62¾"	
MTSSF-60Q	Square	60"x60"x29"	60"x19¼"x72"	
MTSSF-48R	Round	48"x48"x29"	48"x19¼"x62¾"	
MTSSF-60R	Round	60"x60"x29"	60"x20"x72"	
MTSSF-60O	Octagon	60"x60"x29"	60"x20"x75"	
MTSSF-48H	Hexagon	54¾"x48"x29"	54¾"x19¼"x62¾"	
MTSSF-60H	Hexagon	68¾"x60"x29"	68¾"x19¼"x72"	



New! Choose from 3 laminate options (Just replace 'xx' with Laminate code)

MTSSF-60R-MDPEPCxx
MTSSF-60R-MDPECRxx
(Round 60"x60", MDF Core, Black Protect Edge, Textured Black or Chrome Frame, HPL Top)



Model Number Configuration

Model # Core Edge Frame Laminate Color Top
MTSSF-48Q-MD PE CR CH

Add custom height to the end of model number

Convertible Bench Units

*Adaptable for your
cafeteria, auditorium
and testing center!*





Open



See Page 150 for Product Features



Flip



Gang

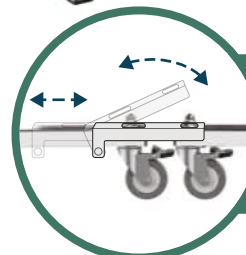
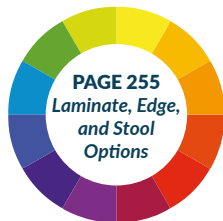
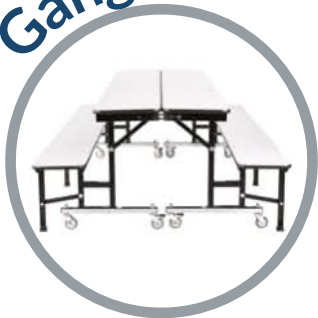

NEW

Additional Optional Ganger

This extra ganger will be installed on the same side as the tabletop ganger.

To order, simply add a "G" to the end of the SKU



CBG96-MDPEPCxx xx
(96"L, MDF Core, Black Protect Edge, HPL Back and Bench)

New! Choose from 3 laminate options (Replace "xx" with one laminate code. The same laminate will be used on the back and bench)

-  Grey Nebula
GY
-  Montana Walnut
WT
-  Fusion Maple
FM

Model #	Seats	Open (WxLxH) Dimensions	Seat Height (Standard)	Folded (WxLxH) Dimensions	Table/Seat Height (Custom)
CBG72	3-4	29"x72"x29"	17"	22¾"x72"x34"	25"-13" 27"-15" 32"-20"
CBG84	4-5	29"x84"x29"	17"	22¾"x84"x34"	
CBG96	4-6	29"x96"x29"	17"	22¾"x96"x34"	

Model Number Configuration

Model # Core Edge Frame Back Laminate

CBG96-MD PE PC CH GY G

Bench Laminate Extra Ganger

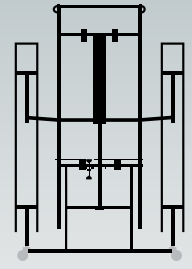

Sophistication made Simple with Safety in mind.

NPS Mobile Tables are sophisticated in design yet simple to operate. Offering enhanced safety features giving you complete peace of mind.

Frame Design *Intelligent steel understructure design supports table tops and seating providing ease of operation and maintenance.*

Table Top Apron Support

- Each top is supported by 2" deep, 14-gauge steel aprons capped at the ends with riveted plastic protectors.
- Aprons and brackets are fastened to wood with custom designed tamper-resistant screws with superior holding power while still easily serviceable if the need arises.
- Tops are supported between the leg top tubes and wood with spacers.

Leg Assembly



- Structural leg components are comprised of 1 1/4" diameter, 14-gauge steel tubing.
- Legs and stool columns are constructed of 1 1/4" diameter, 14-gauge steel tubing and braced horizontally to the stool support column on the opposite side of the table to resist bending.

Lock Rod



- Heavy duty 7/16" diameter lock rod is chrome plated to resist wear.
- Tamper resistant lock nuts on all down lock assemblies with a self-adjusting hinge lock ensure that the down lock engages every time.

Storage Lock

- Heavy duty storage lock is comprised of a 1 1/4" square tube with heavy-duty catch. Locks automatically in storage position and easily release from either side of the table when opening.

Table Top & Seats

Core



- Available in MDF, Particleboard, or Plywood.
- Tops and benches are surfaced with high pressure laminate bonded to a 3/4" thick AC grade core, sealed underneath with a poly backer for T-molded tabletops and a phenolic backer sheet for tabletops with Protect Edge. This is especially helpful when cleaning the underside of the table.

Edge (for table tops and benches)



- Available with Protect Edge, Vinyl T-Molding or 3MM PVC Edge Banding.
- Protect Edge is sealed with a polyurethane epoxy resin, chemically bound to the edge of the laminate, core and phenolic backing sheet.
- Vinyl T-molding is secured by staples to the top's underside approximately every 10".
- 3MM PVC Edge Banding: Heat-applied with EVA adhesive to create a strong, durable, liquid-tight seal between the tabletop and edge. The adhesive withstands temperatures up to 170°F.

Seat

Stools



- Stools are injection molded with a minimum of 25 oz. of UV additive, rubber-modified, high impact polystyrene materials measuring 13" in diameter.
- Ribs, which extend from the outer perimeter of the stool to the mounting hub in the center, are reinforced to resist failure with 12 integrally molded, tapered ribs.



- **Wobble-free** stools are mounted quickly without "wobble" with our custom designed serrated head nut and bolt. Nut also has nylon locking inserts to ensure stools stay tight.
- Power tools are recommended for safe and secure assembly.

Hardware

Table Top Screws



- Serrated head and thick threading provides superior holding power to frame with the ability to be serviced easily in the field.
- Tamper resistant.

Flower Glides and Tube Closures

- Made from glass-infused nylon and spring steel, will not break or fall out.

Casters



- 4" heavy-duty, double ball-bearing casters.
- Weight capacity of 275 lbs. per caster.
- Polyurethane, non-marring wheels.

Operation

Entrances (for bench units)

- Each bench is designed for easy entry on both ends.

Locking - Opening



- A gravity lock automatically locks the table in the open position. The lock is disengaged manually, capable of being operated from both sides of the table.

Locking - Folding



- The storage lock latch automatically locks the table in the folded storage position. The lock is disengaged manually, capable of being operated from both sides of the table and within easy reach.

Custom Torsion Bar System



- Easy opening and closing via a perfectly balanced torsion bar system.
- Each unit includes 1 to 5 torsion bars determined by table size and core material.
- Each torsion bar is at a specific angle based on weight distribution.

Safety

Lift-Off Casters



- Mobile tables incorporate the beneficial caster lift-off design in which casters lift off the floor in the open position.
- Lift-off casters do not protrude past the seats so they are not a tripping hazard.

Midway Position Lock



- Secures the unit in a partially folded position for ease of movement during floor cleaning and to prevent finger or hand pinching.

Storage Lock Latch



- Vertical adjustment ensures that the table always locks safely into the folded position.
- **UL CERTIFIED:** Tested for 7,000 open/close cycles exceeding the UL testing standard of 6,000 cycles.
- **SAFETY POSITION:** Folds in teepee position to prevent tipping.





Booth Seating

*Transforming cafeterias into cafes.
Roll and swivel into booth seating.*

BOOTH | TABLES | BENCHES

ToGo Booth



ToGo Specs



BOOTH SEATING

The ToGo Benches Feature Fixed High Backs With a Slight 12-Degree Pitch Providing the Perfect Contour for Comfortable Seating.



MOBILE

Built With Industrial Grade Steel, and Double Ball-Bearing Non-Marring Casters, the ToGo Provides the Ultimate in Strength and Mobility.



COLLABORATIVE

Today's Cafeterias Have Become Multi-Purpose Spaces Which Require Furniture That Is Mobile and Multi-Functional. NPS's ToGo Booth System Is Ideal for Such An Environment.



SIMPLE STORAGE

The ToGo Bench and the ToGo Flipper Table Top Flip up and Nest for Optimal Storage. Both Are Offered in 48" or 60" Widths and 24" or 30" Depths Providing Comfortable Seating for All Sizes.



LATCH



HEAVY-DUTY CASTERS



GRIP-RITE GLIDE

EASE OF USE

It's Simple to Reconfigure for Multi-Purpose Use. With Heavy-Duty Casters the ToGo Booth is Easy to Move. Rubber Grip-Tight Glides on Benches Automatically Engage with the Floor When Opened Along with Locking Casters to Keep your Seating Arrangement Nicely in Place. Tables Open and Lock Automatically and are Easily Released with the Pull of a Handle.

19" High Back
15" Wide Seat

Compared to standard 15"x12" Convertible Bench



Mobile Booth Bench



Roll In



Flip

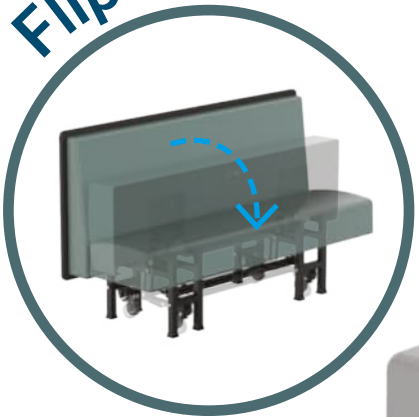

Set Up



*Your Booth. Your Style.
Anywhere You Roll.*



AVAILABLE



SUMMER 2026



Mobile Booth Bench

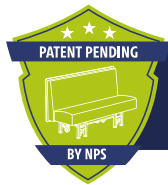

MOBILE BOOTH BENCH
PATENT PENDING
INNOVATIVE ENGINEERING AND DESIGN



CHECK OUR WEBSITE FOR MORE
PRODUCT DETAILS



*Complete your booth by pairing benches
with our Mobile Flipper Tables!*

Cluster Booth Tables



*Encouraging connection, maximizing space,
one cluster at a time.*



BOOTH SEATING | BOOTH OPTIONS
Cluster Booth Tables

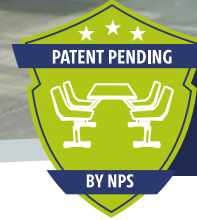

CLUSTER SWIVEL BOOTH
PATENT PENDING
INNOVATIVE ENGINEERING AND DESIGN



Featuring
SUPER FLEX
SEATING



Cluster Booth Tables

with Super Flex Swivel Seats

Featuring
SUPER FLEX
SEATING



Features



Flex Back Tested by SGS Labs to Resist 425 Lbs of Force



Unique Design for Ultimate Seating Comfort



Seats Are Mounted on An Industrial Grade Swivel Base



18-1/2" Space from Tabletop to Seat Back

Seat Colors

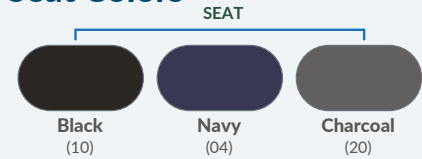

Model Number Configuration

Prefix | Tabletop | Seat Color
CSBG2448 PB**TM** **xx** **10**
 Laminate (If Applicable)

Cluster Booth Tables

with Bench Seating



Features



Fixed 9 3/4" W Benches



13-Gauge Heavy-Duty Steel Brackets for Ultimate Strength

Bench Core Options

Bench Core Will Match Tabletop Core. (Excluding BB or WB)



.75" particleboard core
HPL Surface
T-Molding
(PBTM)



.75" Particleboard
HPL Surface
PVC Edge Banding
(PBEB)



.75" MDF core
HPL Surface
Protect Edge
(MDPE)



.75" Plywood
HPL Surface
T-Molding
(PWTM)
(Only Available with BB or WA Tabletops)

Model Number Configuration

Prefix | Bench Seating | Tabletop/Bench Core | Top Laminate (If Applicable)
CSBG2448 B **BB** **PBTM** **xx** **xx**
 BB/WB Tabletop (If Applicable) | Bench Laminate

Cluster Booth Tables

with Stool Seating

Features



High Impact Stools Reinforced With Embedded Steel Washers

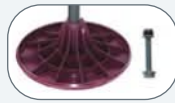

Hex-Head Serrated Flange Bolts & Serrated Flange Nylon Insert Nuts Provides Stronger and Simpler Assembly

Stool Shapes



Round Stool



ErgoMax Stool (E)



Model Number Configuration

Prefix Stool Seating Laminate (If Applicable)

CSBG2448 S PBTM xx 28

Tabletop Stool Color



Shared Features

Shared Features



13-Gauge Heavy-Duty Steel Frame



T-Shaped Legs with Thermoplastic Rubber Glides for extreme stability and floor protection



Undertable 11-Gauge Framing System



Tamper Free Hardware



Seats Mounted with Industrial Grade Steel Seat Mounts

Add-Ons



Optional Floor Mount Kit Secures Booth in a Fixed Position

Model# **CSBG-FCS**

Tabletops

Tabletop Dimensions are 24" x 48"



1.2" particleboard core HPL Surface T-molding (PBTM)



1.2" Particleboard HPL Surface PVC Edge Banding (PB EB)



1.2" MDF core HPL Surface Protect Edge (MDPE)



1.2" Particleboard Core Whiteboard HPL Surface PVC Edge Banding (WB)



1.75" Solid Maple Wood Butcherblock Proprietary UV Finish (BB)

See back for warranty, finish options and care instructions.



products meet or exceed applicable ANSIBIFMA standards

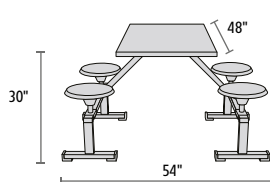
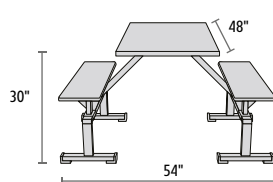
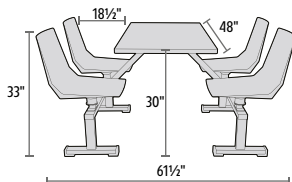

Rated for a 300 lbs weight capacity, these seats were tested by SGS to resist up to 425 lbs of force when flexing, showcasing its robust durability. The pedestal seat mount ensures reliable support and safety within the 300 lbs capacity.



CSBG2448-MDPEGYxx (24"x48" Rectangular, MDF Core, Black ProtectEdge, Grey Nebula Top)

TRASH RECEPTACLE



NEW

Smart, Stylish Waste Solutions for Every Environment

 **NOW IN STOCK!**

-3 SIZES-

32
GALLON



44
GALLON



55
GALLON



Customize Your Trash Receptacle
www.nps.com CHECK OUR WEBSITE FOR MORE
PRODUCT DETAILS



Features



Reinforced Internal Frame Constructed From 12-Gauge Sheet Metal For Heavy-Duty Strength



Round High-Quality Resin Trash Can And Dolly With 3" Rubber Casters Included



Constructed Of .75" Thick Plywood Core with HPL Surface And 3mm Hot-Melt Pvc Edge



Handle And Magnetic Locking System Designed For Smooth And Secure Operation



4 Easy-Lock 3" Double Ball Bearing Heavy-Duty Casters



12" X 12" Square Opening With Rounded Edges



Trash Can and Dolly Included



Standard Models Standard panels are in Grey Nebula Laminate

Model #	Capacity	Dimensions
TR-32GSQPWEBGY	32 Gal	27¼"W x 27¼"D x 42½"H
TR-44GSQPWEBGY	44 Gal	29¼"W x 29¾"D x 46¾"H
TR-55GSQPWEBGY	55 Gal	31¼"W x 31½"D x 49"H

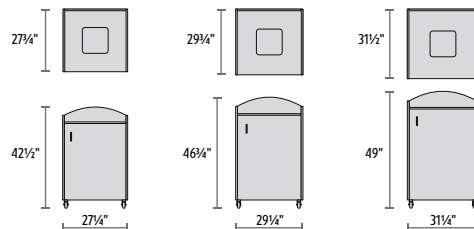

CAFÉ



Bushwick Bentwood Chairs & Stools

Bentwood Chair



Bentwood Counter Height Stool



Bentwood Bar Height Stool



*Step Up Your Style with
Our Bushwick Bentwood
Chairs and Stools!*

See more information on Page 26

CAFÉ | CT SERIES
Fixed Height Tables



Features



Industrial Grade
8-Gauge Steel
Bases



Pole Connects to Base
With Heavy-Duty Bolt
and Thread Locker



Poles Have a 3"
Diameter and a Fully
Welded Base Plate



Leveling Glides
Pre-Installed to
Bases



Poles Feature a Fully
Welded Tabletop
Support Plate





Tabletops



1.2" Particleboard core
HPL Surface
T-molding
(PBTM)



1.2" Particleboard core
HPL Surface
PVC Edge Banding
(PBEB)



1.2" MDF core
HPL Surface
Protect Edge
(MDPE)



1.2" Particleboard core
Whiteboard Surface
PVC Edge Banding
(PBEBWB)



1.2" MDF core
Whiteboard Surface
Protect Edge
(MDPEWB)

THREE HEIGHTS AVAILABLE

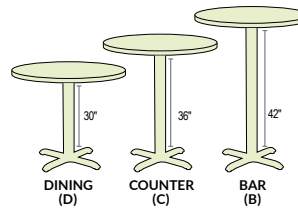

Frame Colors



Black
(no Code)



Soft Grey
(G)

Base Style



T Base
(T)



X Base
(X)



Round Base
(R)

Model Number Configuration

Prefix Shape Size Height Tabletop
CTG 2 3042 T D PBTM xx
 Color (if Grey) Base Style Laminate (HPL Tops)

Shapes



Round
(1)



Rectangle
(2)



Square
(3)



Racetrack
(4)



Curve
(5)

Rectangle & Racetrack Sizes (width/Length in inches)

2430	2436	2442	2448	2454	2460	2472	2484	2496
3036	3042	3048	3054	3060	3072	3084	3096	

Round & Square Sizes (width/Length in inches)

2424	3030	3636	4242	4848
------	------	------	------	------

Curved Sizes (width/Length in inches)

60°: 2491*	108°: 2492*
------------	-------------



● Quick ship tables available in 36" round and square, choose from Grey Nebula (GY) or Figured Mahogany (MY) laminates with Black T-mold (TM)
 *Recommended with T Base

Air-Lift Nesting Pneumatic Café Table

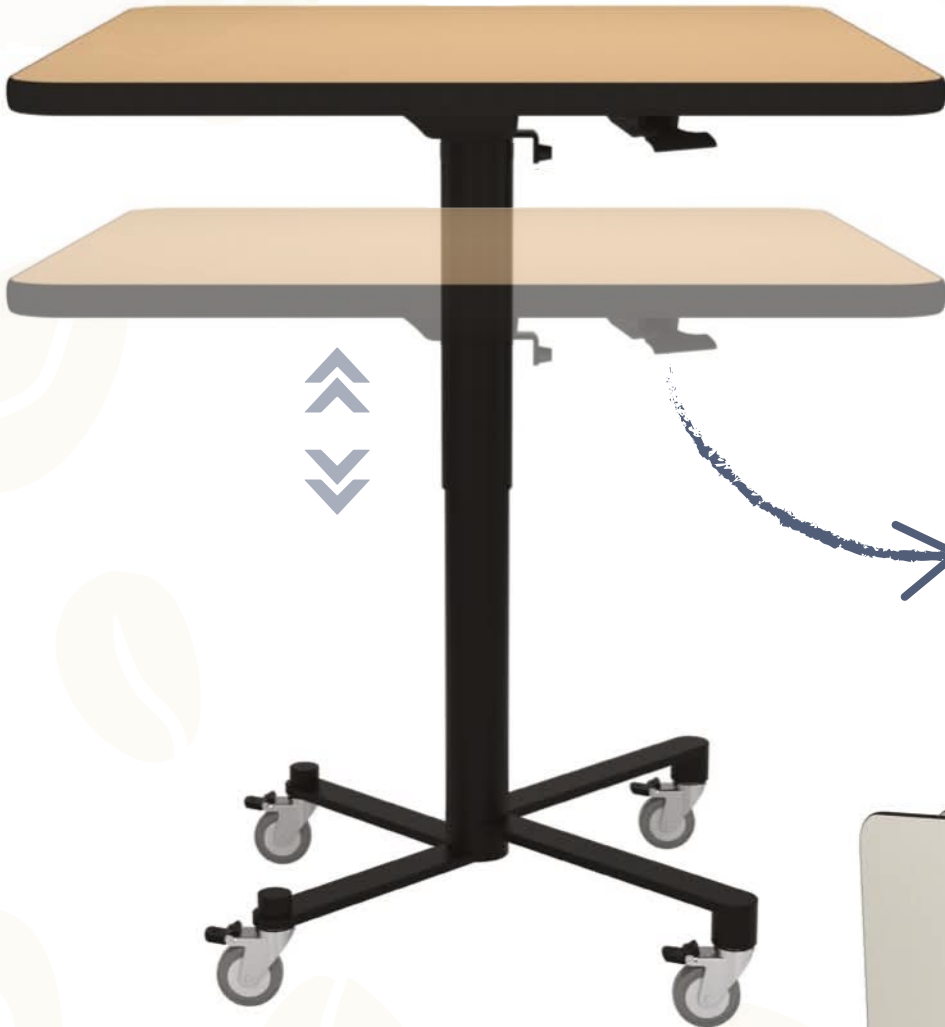

One-click pneumatic height adjustment

Adjust to any height from 30" to 40.5"

Sleek Nesting for space-saving storage



CAFÉ | ACT SERIES
Air-Lift Nesting Pneumatic Café Table



*Durable and
Elegant Design!*

Available with round and square tabletops

Air-Lift Nesting Pneumatic Café Table



Roll In



Flip



Store



SHIPS FULLY ASSEMBLED

Features



Four Locking Heavy Duty Non-Marring Swivel Casters



Heavy-Duty 13-Gauge Steel Column



1/2" Thick Solid Steel Base



Effortless height adjustment with our easy-to-use pneumatic system



Easy-Use Handle for Flipping



Bumpers to protect tabletops when nesting

Café Time



Roll In



Flip



Store



Color



Charcoal Slate
Silver Tone Frame

Table Features



Concealed Pneumatic Lever Makes for Effortless Raising and Lowering



Casters and Glides Included



Tabletop Sets Into Vertical Position For Compact Storage

Chair Features



Rubber Glides To Protect Floors



Stacks For Easy Storage



Scratch Resistant, Attractive Chair Seats & Backs

Model# Description

CTT3042	Café Time Adjustable-Height Table
CTS30	Café Time Stool

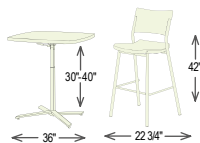





MUSIC

Melody Chair®

8210, 8210-16,
TA82R, TA82L,
TR82, BR82U



Music Stand

82MS



Conductor

CSS, CP, CS, CTS



MUSIC | 8210 SERIES

Melody Chair®



Take a Seat, Set the Tone



TWO HEIGHTS AVAILABLE

8210 | 17.5" Seat Height

8210-16 | 16" Seat Height



Designed for Music Rooms,
Perfect for All Spaces



97°

Leg Weld Design

Exclusive to NPS, our patented leg weld design enhances strength and durability while delivering a sleek, professional aesthetic. The curved end caps safeguard your valuable instruments from damage.

Melody Chair® Jr.

(16" SEAT HEIGHT VS. 17.5" ON THE 8210)

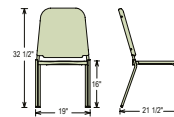

Model Number
8210-16



Stacks
18
CHAIRS

on Page 214
Compatible with **DOLLY**
DY82

1-2 DAY LIGHTNING SHIP

Melody Chair® Features



7/8" Frame with 16-Gauge Square Tubing and 14-Gauge Rear Seat Brace



Durable Polypropylene Contoured Seat For Extra Comfort



Curved, Tight Plugs



Music Band-Pitch Style With a Seat Back Angle Of 97°

Model Number
8210

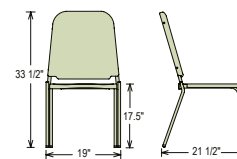

WEIGHT CAPACITY
300
lbs

BIFMA
INTERNATIONAL
ANSI

products meet or exceed applicable ANSI/BIFMA standards

CERTIFIED GREEN
GREEN SOURCE
GREENGUARD
GREENLAB

TAA

1 year warranty
10

Melody Chair® Accessories

Note: Chairs can't be stacked when any accessory is installed.



Right Tablet Arm
TA82R



Left Tablet Arm
TA82L



Tuba Rest
TR82

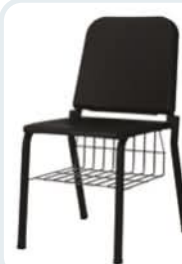

Book Rack
BR82U

NEW

MUSIC | 82MS SERIES
Melody Music Stand

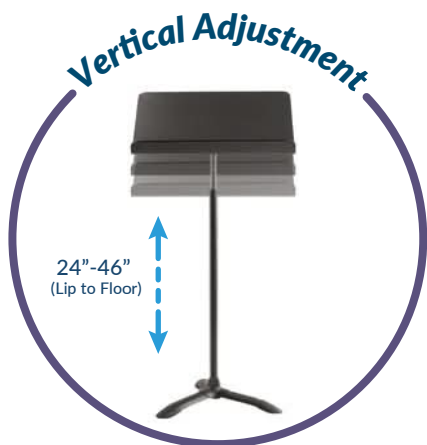

Model Number
82MS



Music Stand Features



Tension Tilt Surface For Smooth Adjustment



Neck Assembly Provides A Tighter Fit On Pole



Rubber Tips Included To Prevent Noise And Floor Scratching

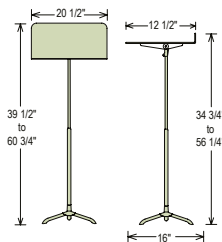

Dollies Category on Page 214
 Compatible with **DOLLY**
 DYMS10, DYMS20



products meet or exceed applicable ANSIBIFMA standards

MUSIC ROOM



CONDUCTOR'S FURNITURE



Roll With Ease Using Built in Casters



Color

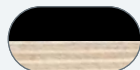

Black Carpet
 Black Side Panels
 Plywood Core

Model Number
CP

CP Conductor Podium

Overall	12"H X 39.5"W X 44.25"D
Step	5.75"H X 39.5"W X 10.5"D

Features



Industrial Grade
 14-Gauge Frame



Carpeted Surface and
 Textured Sides for
 Modern Aesthetics



Removable Guardrail
 Also Functions as a
 Handle for Transport



Transport Vertically
 With Four Built-in
 Casters

MUSIC | CS SERIES
Conductor's Stand



CONDUCTOR'S STAND
PATENTED
 INNOVATIVE ENGINEERING AND DESIGN



Features



Adjustable Height
 Telescopic Pole



Heavy-Duty Knob
 Locking Mechanism



Removable
 Accessory Tray



8-Gauge Steel
 Designer Base

Color



Black

Model Number
CS



CS Conductor Stand

Reading Surface	26.75" X 19.75"
Adjustable Height	33.75" - 52.75"



All Conductor Furniture
Available as a Kit



Model Number
CCS

Features



Plush Padded
Seat and Back



Adjustable Height
Footrest With
Locking Knob



Height Adjustable
from 24.5" to 34.5"
With Pneumatic Lift



Plastic Reinforced
Backrest and Seat

Model Number
PCC



products meet
or exceed applicable
ANSI/BIFMA standards

ROOM DIVIDERS

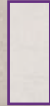
 **ALUMINUM FRAMING**
Encasing Each Panel

**BUILT-IN
MAGNETIC GANGING** 

 **SOUND DAMPENING PET**
*Noise Reduction Coefficient of .55
Sound Absorption Average of .54*



ROBUST

EASY

PORTABLE

FULL LENGTH HANDLE
For Easy Manuverability



3/16" ACRYLIC
Frosted and Clear Options



STEEL FOOT PEDAL LOCK RELEASE

DIVIDERS Robo Dividers



ROLL IN



FOLD



SET UP



GANG





Features



Panel Position Regulators



Full Length Handle



Built-in Magnetic Ganging Mechanism on Top and Bottom



Foot-Pedal Activated Lock-Release Enables Effortless Folding



Auto-Click Panel-Locking Mechanism Keeps Panels Secure When Folded



Self-Leveling Spring Mechanism on All Casters



Each Panel Is Encased in Aluminum Framing



Tech-Lock Brake on 3" End-Panel Casters



PET Panels Are Tackable



PET Panels Are B1-Grade Flame Retardant



PET Panels Have a Noise Reduction Coefficient of 0.55 & Sound Absorption Average of 0.54



PET Panels Are Made of Environmentally Friendly Recycled Materials

Divider Lengths

6' Standard height

3 Panels
72"

5 Panels
118"

7 Panels
164"

9 Panels
210"

11 Panels
256"



Panel Type

SOUND ABSORBING PET



Grey
(PT02)



Blue
(PT04)



Black
(PT10)

OPTIX® ACRYLIC

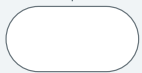

Clear
(CA)

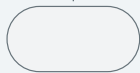

Frosted
(FA)

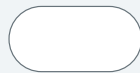

Whiteboard
(WB)

Base Model # Description

RDB6	Black Frame, 6ft High
RDG6	Grey Frame, 6ft High

Frame Color



Black
(B)



Grey
(G)

Panels # Closed Dimensions

3 Panels	32 1/2" x 27 1/2" x 72"H
5 Panels	34" x 27 1/2" x 72"H
7 Panels	35 1/2" x 27 1/2" x 72"H
9 Panels	37" x 27 1/2" x 72"H
11 Panels	38.5" x 27 1/2" x 72"H

Model Number Configuration



7 DAY
QUICK SHIP

Robo Dividers with Sound Absorbing Pet (PT02, PT04 and PT10) and Clear Optix® Acrylic (CA) Panel Type





Design Your Perfect Stage!

Explore our new Stage Configurator

Create, customize, and visualize your ideal stage setup in minutes. Choose from a variety of options and configurations, *available now on our website!*

nationalpublicseating.com/stage-configurator



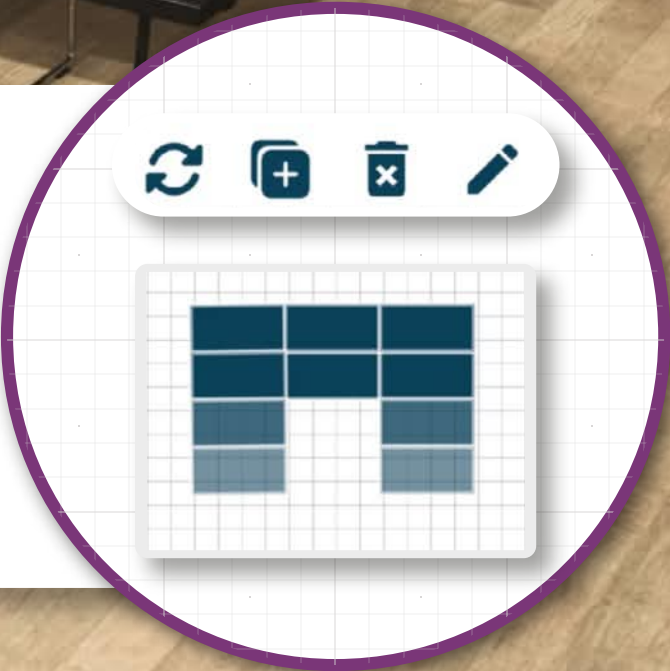

STAGES AND RISERS

Stages

S, SP, SST, TFXS, SG



Risers

RT, RS, TP, SBRC, SCRC



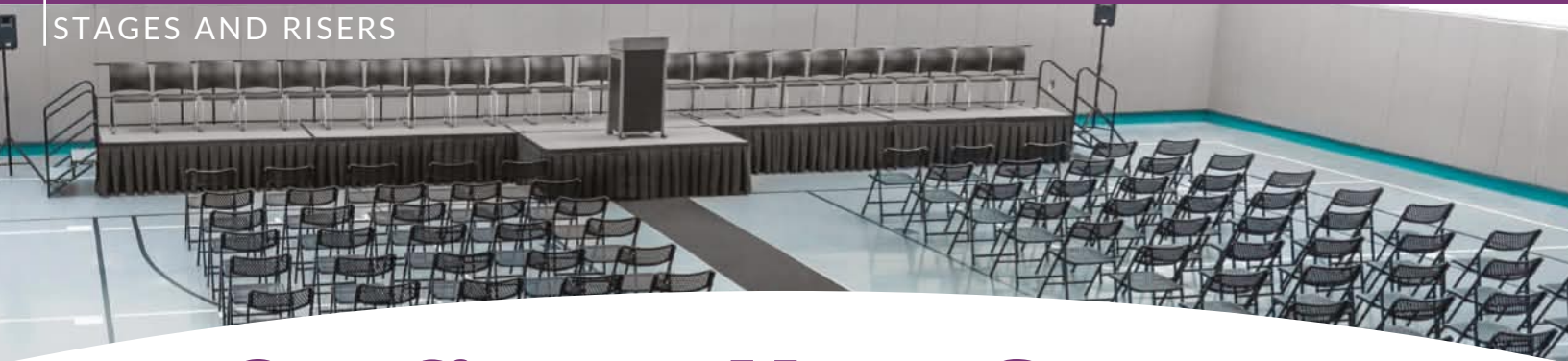

Configure Your Stage

WIDTH, HEIGHT AND SURFACE TYPE



Sizes

WIDTH

36" 48"

HEIGHT

8" 16" 24" 32"

Surface Options

CARPET

Black (C-10) Blue (C-04) Grey (C-02) Red (C-40) Hardboard (HB) Polydeck (P) **NEW**

Model Number Configuration

Model Number | Height

S488C-10

Width | Surface

Features

- 14-Gauge Tubular Steel Legs
- 16-Gauge Steel Frame
- 0.75" Thick Plywood Core
- Ganging To Easily Connect Multiple Stages
- 96" Standard Length
- 200 LBS/FT²** Tested by SGS Labs to Exceed 200 lb/Sq Ft Weight Capacity

10 Year Warranty

CERTIFIED GREEN

TAA

DESIGNED, ENGINEERED & ASSEMBLED IN THE U.S.A.

WITH GLOBAL MATERIALS

Create Curved Configurations

Using Stage Pies

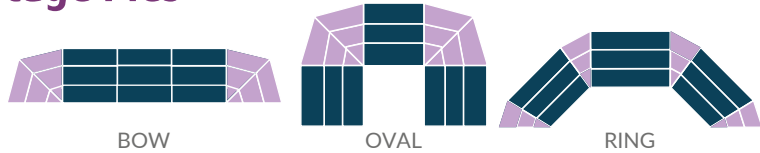

Sizes

WIDTH

36" 48"

HEIGHT

8" 16" 24" 32"

Model Number Configuration

Model Number | Height

SP36 8 C-04

Width/Depth | Surface



Surface Options

CARPET

- Black (C-10)
- Blue (C-04)
- Grey (C-02)
- Red (C-40)
- Hardboard (HB)
- Polydeck (P) NEW

Create Seated Risers

Single-level stages combine with gangers to create multi-level surfaces. Use below configuration codes for multi-level sets.

Straight sets



See Accessories

Page 200

Stage Packages

Page 201

Pie sets



Level Code

- 2L 2 levels; 8" and 16" Heights
- 3L 3 levels; 8", 16", and 24" Heights
- 4L 4 levels; 8", 16", 24" and 32" Heights

Model Number Configuration

Model Number | Width | Level Code

SPST 48 2L C-10

Add "P" for pie set | Surface



Choral Risers

Combine Risers for Straight or Curved Configurations

Straight Edge

Code "RS"



Tapered Edge

Code "RT"

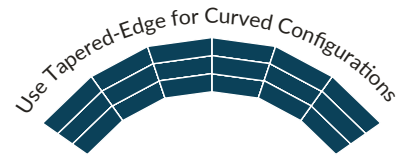

Sizes

WIDTH

18"

HEIGHT

8" 16" 24" 32"

Surface Options

CARPET

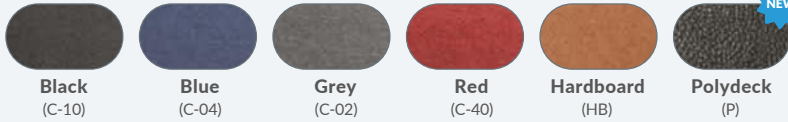

Model Number Configuration

Edge Code | Height
RT 24 C-10
 | Surface

Single-level risers combine with gangers to create multi-level surfaces. Use below configuration codes for multi-level sets.



Edge Code

STRAIGHT

Code "RS"

TAPERED

Code "RT"

Level Code

2L 2 levels; 8" and 16" Heights

3L 3 levels; 8", 16", and 24" Heights

4L 4 levels; 8", 16", 24" and 32" Heights

Model Number Configuration

Edge Code | Level Code
RS 2L C-10
 | Surface



TransPort Riser

Available with straight or tapered edges and a fourth-level add-on

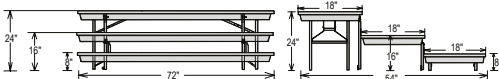

Model Numbers

- TP72 Straight Riser
- TPR72 Tapered Riser
- TPA 4th Level Straight Add-on
- TPRA 4th Level Tapered Add-on

STAGES AND RISERS

Easy Set Flip-Up *Mobile Risers*



CHECK OUR WEBSITE FOR MORE

PRODUCT DETAILS

ROLL IN

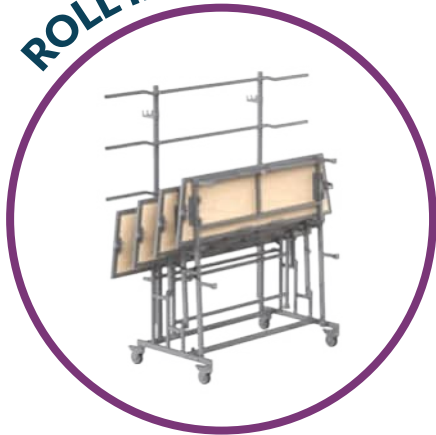

SET UP



PERFORM



Easy Set Flip-Up Mobile Risers



Move. Set. Perform.
The Ultimate Riser on the Go.

AVAILABLE

SUMMER 2026

Innovative
S-DESIGN
Guardrail



Available in

3-LEVEL & 4-LEVEL

with built-in backrail



EASY SET FLIP-UP MOBILE RISER
PATENT PENDING
INNOVATIVE ENGINEERING AND DESIGN

BY NPS

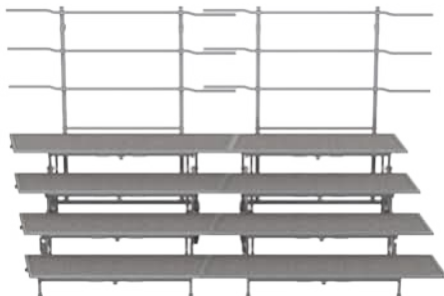

Rotate steps effortlessly to create curved or straight setup.

✓ *No tools required!*

A smarter, faster way to stage any performance.

Designed for easy mobility and quick setup, these innovative risers move smoothly from storage to stage while supporting flexible layout configurations. A forward-thinking addition to our risers offering for today's performance spaces.

Configurable Design for Multiple Performance Layouts

STRAIGHT



BOW

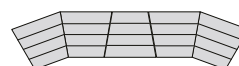

RING

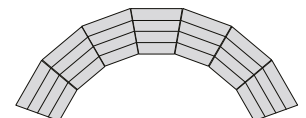

Transfix Stages

Adjustable Height Stages for Built-in Multi-Level Capabilities



Sizes

WIDTH/LENGTH

48"x48"

48"x96"

ADJUSTABLE HEIGHTS

16"/24"

24"/32"

Model Number Configuration

Prefix Width/Length
TFXS 4896 1624 C-10
 Height Surface

Surface Options

CARPET



Features

**200
LBS/FT²**

Tested by SGS Labs to Exceed 200 lb/Sq Ft Weight Capacity



2 Heavy Duty Casters Lift Off When Set Up



14-Gauge Legs Adjustable to Two Heights



Built in Gangers for Multi Stage Configurations

See Accessories



Page 213



Stage Packages

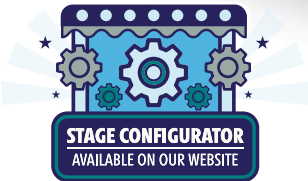

CREATE YOUR OWN PACKAGE

1. Choose Stage Height
2. Choose Quantity of Stages
3. Choose Surface Type and Color
4. Choose Skirting Type and Color

WE WILL CONFIGURE THE REST.

Each package includes guard rails on 3 sides, skirting on all sides, and 2 sets of steps.

Skirting Options

Type



Box pleat skirting (SB)



Shirred pleat skirting (SS)

Color



Black (10)



Navy (04)



Burgundy (08)



Green (06)

Surface Options

CARPET



Black (C-10)



Blue (C-04)



Grey (C-02)



Red (C-40)



Hardboard (HB)



Polydeck (P)

NEW

Model Number Configuration

Prefix | QTY of Stages | Skirting Color
SG48 24 04 C-10 -SB 08
 Height | Surface | Skirting Type

Sample Configurations

Model#	Description
SG482404	16' X 8' X 24"
SG481610	20' X 16' X 16"
SG482410	20' X 16' X 24"
SG483210	20' X 16' X 36"
SG482412	24' X 16' X 24"
SG362404	12' X 8' X 24"

Add surface and skirting codes to the end of Model #



Riser Packages

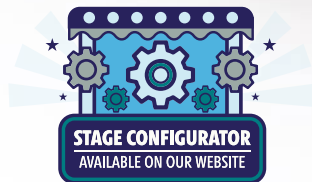
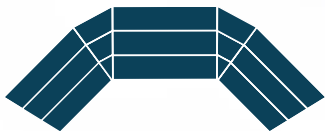
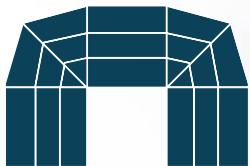
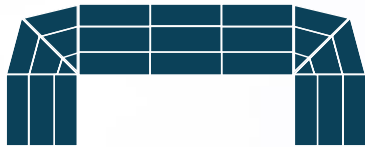
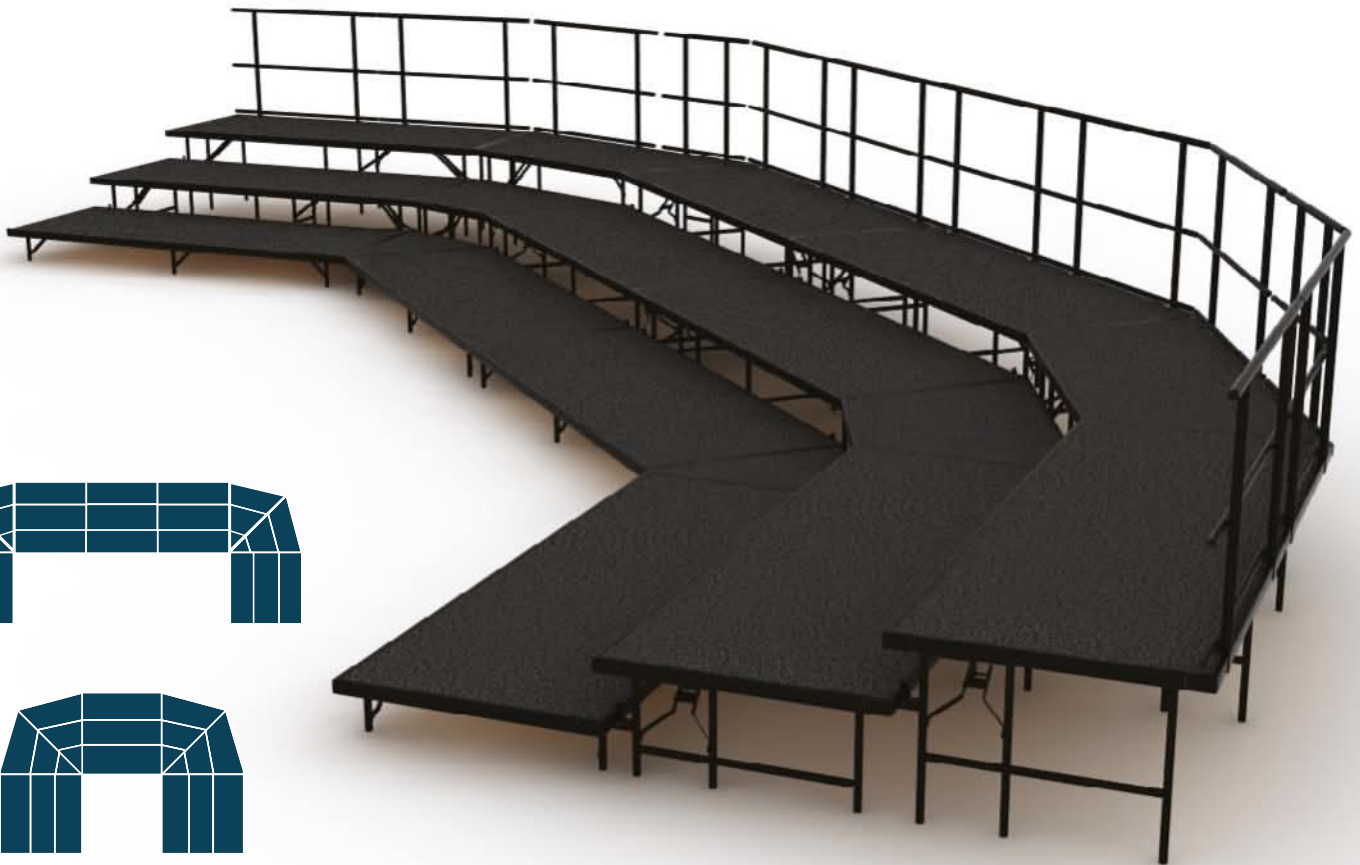

Surface Options

CARPET



Use progressive heights for Seated Bands or Choral Riser Configurations

Package Options

Model#	Includes
SBRC48	3 sets of SST48 (48" x 96" straight stages) and 4 sets of compatible SPST48 (pie stages) and guard rails
SBRC36	3 sets of SST36 (36" x 96" straight stages) and 4 sets of compatible SPST36 (pie stages) and guard rails

Model Number Configuration

Base Model

SBRC48 C-10

Surface Option





A. Back Guard Rail For use with choral risers

Model#	Description
GRR24S	Back Guard Rails for 3 Level Straight Standing Choral Risers
GRR32S	Back Guard Rails for 4 Level Straight Standing Choral Risers
GRR24T	Back Guard Rails for 3 Level Tapered Standing Choral Risers
GRR32T	Back Guard Rails for 4 Level Tapered Standing Choral Risers
GRTPR3	Back Guard Rails for 3 Level TransPort Riser
GRTPR4	Back Guard Rails for 4 Level TransPort Riser

B. Side Guard Rail For use w/ standing risers in 3 heights

Model#	Description
SGRTP3	Side Guard Rails for 3 Level TransPort Riser
SGRTP4	Side Guard Rails for 4 Level TransPort Riser
SGR2L	Side Guard Rails for 2 Level Standing Choral Risers
SGR3L	Side Guard Rails for 3 Level Standing Choral Risers
SGR4L	Side Guard Rails for 4 Level Standing Choral Risers

Chair Guard

Model#	Description
CG28	Chair Guard for SP368 Stage Pie
CG32	Chair Guard for Sides of 3' x 8' Stages
CG37	Chair Guard for SP488 Stage Pie
CG44	Chair Guard for Sides of 4' x 8' Stages
CG54	Chair Guard for SP3616 & SP4824 Stage Pie (2 EA. Needed for SP4824)
CG72	Chair Guard for SP4816 Stage Pie
CG81	Chair Guard for SP3624 Stage Pie
CG96	Chair Guard for Back of Stages (3' x 8' & 4' x 8')

C. Dolly For use with stages & seated risers (Minimum 36" widths)

Model#	Description
SDL	Stage Dolly for Use with 36" W or 48" W Stages

D. Steps For stages in 3 heights

Model#	Description
STP16	Steps for 16"H Stages
STP24	Steps for 24"H Stages
STP32	Steps for 36"H Stages

E. Stage Guard Rail

For use with stages	
Model#	Description
GRS30	30"W Guard Rail for Stages
GRS36	36"W Guard Rail for Stages
GRS48	48"W Guard Rail for Stages

Skirting Options

Model Number Configuration



Skirting Type

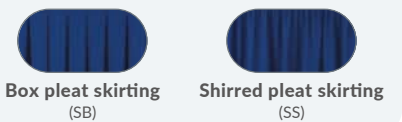

Size



Skirting Color



DOLLIES

DY-MPD



18" Seminar Tables



30" Rectangular Tables



Stages



Choral Risers



Redefining *Multi-Purpose* Storage and Transport

Precision Engineering, Superior Functionality



Adjustable Thermoplastic Grip Handle

Featuring a height-adjustable thermoplastic coated handle for a secure hold and comfortable maneuvering.



Support Posts for Secure Transport

Featuring 2 removable support posts, that secure tables at various points, ensuring stable and safe transportation for all table sizes and shapes.



Dual Handle Posts

Two tubular handles: one at the front with a thermoplastic grip for comfort pushing, and another at the rear for easy assistance with pulling.

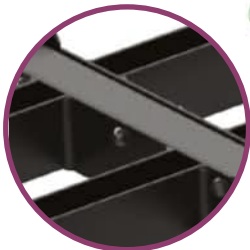

Super-Duty Construction

Built from 14-gauge black powder-coated tubular steel.



Adjustable Angle Supports

Customize angle for secure and versatile storage and transportation for different width products.



Super-Duty Caster System

Equipped with super duty 5" casters: 2 swivel/locking casters at the front, 2 swivel casters in the middle, and 2 fixed casters at the rear for smooth maneuverability and secure positioning.

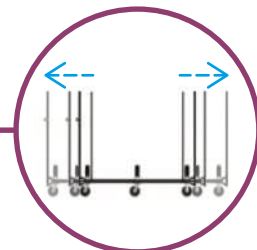

Extendable Design

Adjustable to three load lengths - 60", 72", and 96" - to accommodate various sizes of tables and stages.



Experience the ease and convenience of moving with the **Ultimate Multi-Purpose Transportation Dolly** – your go-to solution for all heavy-duty storage and transport needs!



Compatible Product Series

All Rectangular Tables, Stages, and Risers

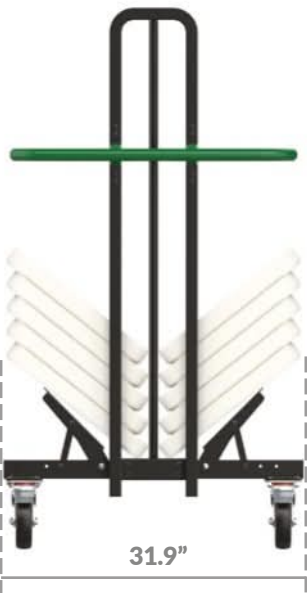

Designed for narrow doorways! Our angle supports enable double stacks of 18" seminar tables to fit through a 32" wide doorway!

Features



6 super-duty 5" hard rubber casters, 2 Fixed, 2 Swivel, and 2 Swivel/Locking



Crafted from durable 14-gauge tubular steel and sheet metal with a sleek textured black powdercoating



Customize the angle supports for secure and versatile storage and transportation of difference width products.



Easily adjusts to handle 60-inch, 72-inch, or 96-inch long tables and stages



Thermoplastic-coated handle offers three height settings for added comfort



Fully Welded Hawk Connection support bracket



Easily lock/unlock with a single downward motion, protecting your shoes from scuffs



Super-duty telescoping frame mechanism

Angle Support Configuration

To load 18" wide items (For 32" doorway)



Set the Angle Supports to Hole "1"

To load 19" to 30" wide items (For 32" doorway)



Set the Angle Supports to the Flat Position on the Same Side as the End Axle Holes. On the Opposite Side, Set the Angle Supports to Hole "3"

To load bigger than 30" wide items



Set the Angle Supports to Flat Position

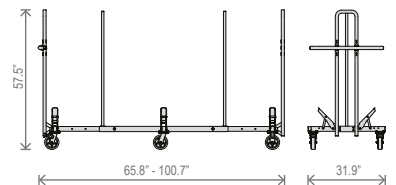

⚠ Double check all bolts to be tightened securely before use. Check all bolts periodically. Failure to completely tighten the bolts may result in tipping and possible injury!





TAD

TABLE ASSIST DOLLY

For Use with 4', 5', 6' or 8' Rectangular Tables



SETTING UP YOUR TABLE IS AS EASY AS 1-2-3

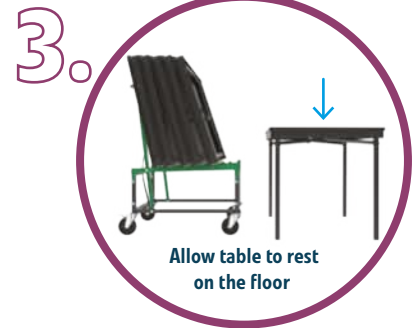
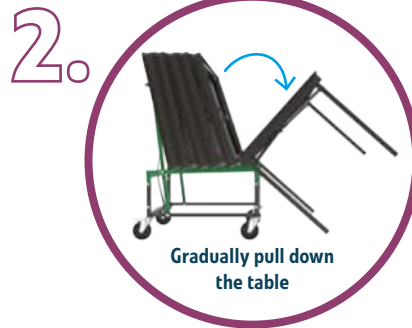
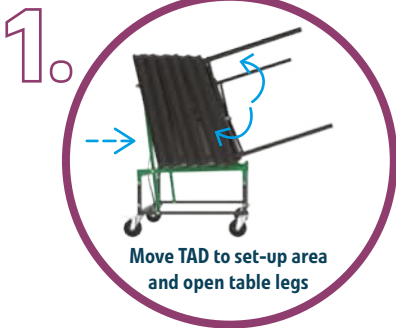

Features



Plastic Coated Table Support Frames



4 Swivel/ 2 Locking Casters



7/8" O.D. Steel Handle (18-Gauge)



5 X 1.25" Hard Rubber Casters



1" Square 14-Gauge Tubular Frame



Textured Black Powder-Coated Steel

Compatible Table Series

BT1800 BT2400 BT3000 MSFT*

*Rectangle tables only

Quantity of Tables

10

5

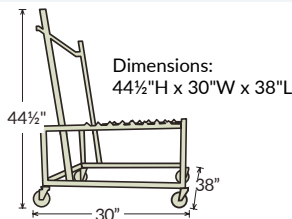

Storage and Transport Dollies

DYMU

Equipped with a Center Bar to Support Small Table Sizes.
Featuring Carpeted Table Supports for Added Table Protection.



Compatible Table Series

BT2400 BT3000 BT48R BT60R

MSFT48RD MSFT60RD MSFT Rectangular

Quantity of Tables

8-10



DY-71R

Equipped with an Extra Bar For Additional Support
Featuring Carpeted Table Supports for Added Table Protection.



Compatible Table Series

BT48R BT60R BT71R

Quantity of Tables

8-10



DY-60R

Equipped with a Tubular Handle for Stability & Easy Handling.
Featuring Carpeted Table Supports for Added Table Protection.



Compatible Table Series

BT48R BT60R MSFT48RD MSFT60RD

Quantity of Tables

8-10



DY-3072

Tables up to 72" long

DY-3096

Tables up to 96" long



Compatible Table Series

All Rectangular

Quantity of Tables

12



Storage and Transport Dollies

Model 42



Seamless mobility in a compact, stable, and sturdy design.

Compatible with our Basics by NPS Personal Tables!



Convenient handle included for effortless transport



Compatible Chair Series

50	200	300	600	800	1200
1300	1400	2200	2300	3200	

Quantity of Chairs 42 **36**

Compatible Table Models

PT3020

Quantity of Tables 30

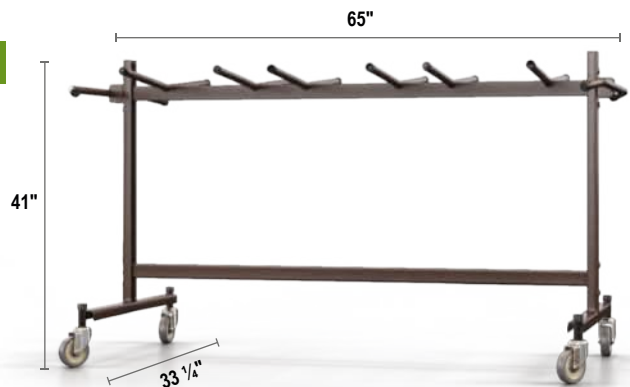

DOLLIES | 84/42-8/EXT-8/C-60 SERIES
Storage and Transport Dollies

Model 84

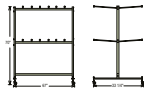

Compatible Chair Series

50 200 300 800 1200 1300 2200 2300

Quantity of Chairs **84**

Model 42-8

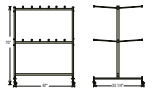

Compatible Chair Series

50 200 300 **600** 800 1200 1300 1400 2200 2300

Quantity of Chairs **42** **36**

Compatible Table Models

BT3072 BT3096 **PT3020**

Quantity of Tables **8-10** **30**



Model 84/EXT-8

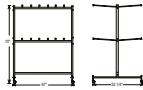

Compatible Chair Series

600 1100 **1400** **3200**

Also any chairs compatible with 84

Quantity of Chairs **72** **60** **84**

Model 84-60 | 84/EXT-8-60 | 42-8-60

Convert the top level of your dolly into a coat rack by adding -60 to the end of the model number



Available Accessories



EXT-8

Available for model 84



MODEL C-60

Available for Model 84/42



DOLLIES | DY-35/DY-50/DY1100/DY1400/USCDK SERIES
Storage and Transport Dollies

DY-35



USCDK Use this handle kit DY35 and DY50 for understage storage



DY-50

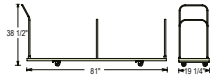

Compatible Chair Series

50	200	300	600	800	1100	1200	1300	2200	2300	3200
----	-----	-----	-----	-----	------	------	------	------	------	------

Quantity of Chairs

24	28	35	30
----	----	----	----

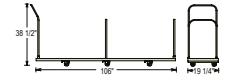

Compatible Chair Series

50	200	300	600	800	1100	1200	1300	2200	2300	3200
----	-----	-----	-----	-----	------	------	------	------	------	------

Quantity of Chairs

35	40	42	50
----	----	----	----



DY1100



DY1400

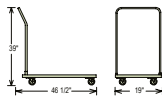

Compatible Chair Series

1100

Quantity of Chairs

26

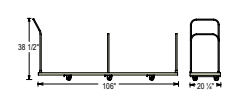

Compatible Chair Series

1400

Quantity of Chairs

52



DY700/800



Optional
Strap
Available
Model DYS8

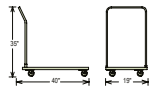

Compatible Chair Series

800

Quantity
of Chairs

36

DY81



Compatible Chair Series

8100 BCC BCM BCS
 9200 9300 9600

Quantity
of Chairs

10

4-6



DY82



Compatible Chair Series

8210 8210-16

Quantity
of Chairs

18

DY85



Compatible Chair Series

8500

Quantity
of Chairs

40



Storage and Transport Dollies

DY87



Compatible Chair Series

8700 8800

Quantity of Chairs 35

DY87B



Compatible Chair Series

8700B 8700C 8800B 8800C

Quantity of Chairs 24



DY-9000



Compatible Chair Series

9100 9200 9300 BCC

Quantity of Chairs 8-10 4-6

DY86



Compatible Chair Series

8600

Quantity of Chairs 20



DOLLIES | DYCL-85/SDL/DYMS10/DYMS20 SERIES
Storage and Transport Dollies

DY-CL85



Compatible Chair Series
 850-CL

Quantity of Chairs 30

SDL



Compatible Stages
 36"W 48"W

Quantity of Stages 6



DYMS10

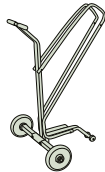

Compatible Music Stands
 82MS

Quantity of Stands 10

DYMS20



Compatible Music Stands
 82MS

Quantity of Stands 20







LECTERNS

Lecterns

GSL, 22, 112, 222, 70,
600, 401S, 611



Sound Lecterns

ZED, GSL-S, 111PLS,
800x, 6010, 950/901



Greystone Lectern



ELEGANT

Designer curved grey plywood for a more sophisticated look.



VERSATILE

Steel cabinet and hooded twin wheel matching casters allow for added storage and mobility.



MULTI-MEDIA

Large reading surface and pull-out shelves for a complete multi-media presentation experience.



Features



Sleek Grey Plywood Provides A Smooth Writing Surface



Quality Lock For Secure Storage



3" Twin Wheel TPR Two-Tone Casters



Two Shelves and Drawer for Convenient Storage

GSL SERIES GREYSTONE LECTERN

Reading Surface: 22.75"W x 18.25"D
Side pull out trays (R & L): 14.25"W x 12"D
Front pull out tray: 17.5"W x 9.25"D
Top two cabinet shelves: 21"W x 14.75"D x 7"H
Bottom cabinet shelf: 21"W x 14.75"D x 12"H
Drawer: 6.25"W x 15"D x 13.25"H
Product Weight: 89 lbs.



Full Floor Lectern
222 Series



TableTop Lectern
22 Series



Lectern Base
112 Series



222 SERIES

Colors



Mahogany
222-MY

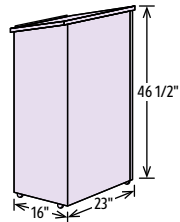

DIMENSIONS: 46.5"H
X 23"W X 16"D
WEIGHT: 56 LBS.

22 SERIES

Colors



Mahogany
22-MY



Black
22-BK

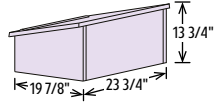

DIMENSIONS:
13.75"H X 23.75"W X 19.875"D
WEIGHT: 31 LBS.

Features

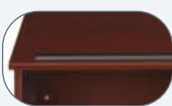

Built in Paper/
Bookstop

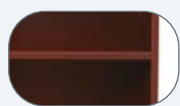

Convenient
Shelf for Storage

Accessories



2CS
Caster Kit
Optional for 222
included with 112

112 SERIES

Color

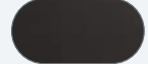

Black
112-BK

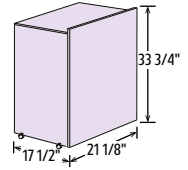

DIMENSIONS: 33.75"H X 21.125"W X 17.5"D
WEIGHT: 50 LBS.
TOP SURFACE WEIGHT CAPACITY: 75 LBS



**Portable Presentation Lectern
70 Series**



**Aristocrat Floor Lectern
600 Series**



**1-2 DAY
LIGHTNING SHIP**

ten year
warranty
10

Features



Adjustable Height
From 30" - 44" and
Adjustable Glides



Features a
Generous 20"Wx16"L
Reading Surface

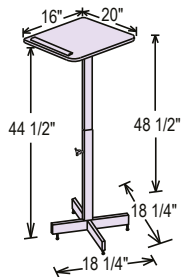

Colors



Medium Oak
70-MO



Mahogany
70-MY



Wild Cherry
70-CH

Features



4 Easy-Roll
Casters, 2
Locking



Side Mounted Slide
Out 15"Wx16"L Shelf
For A/V Presentation
Equipment

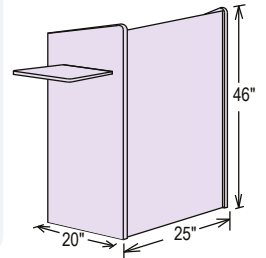

Colors



Medium Oak
600-MO



Mahogany
600-MY



Wild Cherry
600-CH

Clear Acrylic Podium
401S Series



Model Number
401S

Features



Features a
Convenient Shelf



Broad 23.5"X24"
Reading Surface



Built-in Acrylic
Book Stop

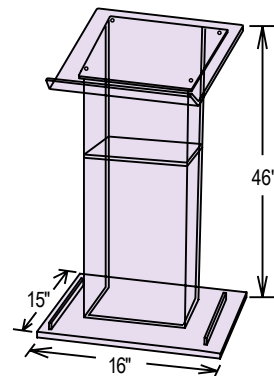

Vision Lecterns

Vision Lectern
611 Series



Color



Ribbonwood
611-RW



Features



Four Concealed Casters, Two Locking



¾-Inch Stain and Scratch Resistant Thermofused Melamine Laminate on MDF



Built in Paper/Bookstop



Two sizeable 14.5" x 23" shelves for ample storage

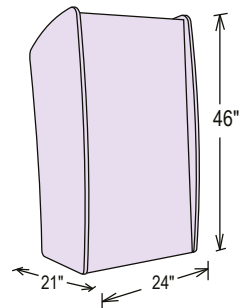

Overall Dimensions: 46"Hx24"Wx21"D
Interior shelf: 14.5"Dx23"W



SOUND LECTERNS

ZED Lectern

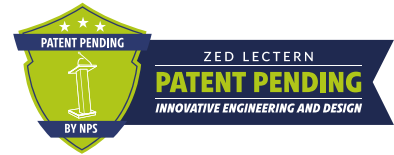

Features



Equipped With Condenser and Dynamic Microphone Inputs



Includes One Gooseneck Mic and One Tie-Clip/Lavalier Mic



Amplifier Supports Bluetooth/USB Inputs



Built-in Tone Control Capabilities



Output Lines for Auxiliary Speakers



Featuring 4 Concealed Casters



Equipped With a Halogen Lamp



Four 4" 40W Speakers



Durable Scratch Resistant Surface



High-Pressure Thermal-Fused Laminate on an MDF Core

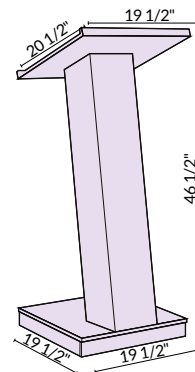

Product Feature	ZED
Overall	19.5"W x 19.5"D x 46.5"H
Reading Surface	19.5"W x 20.5"D
Product Weight	47.6 lbs.
Mics	21" Gooseneck
AMP	40W



LECTERNS | GSL-S SERIES
Greystone Lectern with Sound

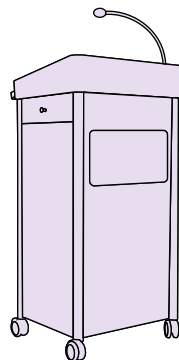

Features



Includes One Flexible Gooseneck Mic and One Tie-Clip/Lavalier Mic



Equipped With Condenser and Dynamic Microphone Inputs



Amplifier Supports Bluetooth/USB Inputs and Output Lines for Auxiliary Speakers



Sleek Grey Plywood Provides A Smooth Writing Surface



Two Shelves and Drawer for Convenient Storage



3" Twin Wheel TPR Two-Tone Casters

Product Feature	GSL-S
Overall	23.5"W x 19.25"D x 45.5"H
Reading Surface	22.75"W x 18.25"D
Side Pull Out Trays (R & L)	14.25"W x 12"D
Front Pull Out Tray	17.5"W x 9.25"D
Top Two Cabinet Shelves	21"W x 14.75"D x 7"H
Bottom Cabinet Shelf	21"W x 14.75"D x 12"H
Drawer	N/A
Product Weight	95 lbs.
Mics	21" Gooseneck
AMP	30W

Optional Suffix	Description
/LWM-5	Add Wireless Handheld Mic
/LWM-6	Add Wireless Tieclip Mic
/LWM-7	Add Wireless Headset Mic

Optional Prefix	Description
M	Add Rechargeable Battery



**Power Plus Lectern
111PLS Series**



**The Orator
800X Series**



**1-2 DAY
LIGHTNING SHIP**



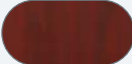

Color

Mahogany
111PLS-MY

Ribbonwood
111PLS-RW

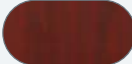
Color

Mahogany
800X-MY



Ribbonwood
800X-RW

Upgraded Amplifier with Bluetooth/USB Inputs

Base Model	Description
111PLS-MY	Power Plus Lectern - Mahogany
111PLS-RW	Power Plus Lectern - Ribbonwood

Optional Suffix	Description
/LWM-5	Add Wireless Handheld Mic
/LWM-6	Add Wireless Tieclip Mic
/LWM-7	Add Wireless Headset Mic

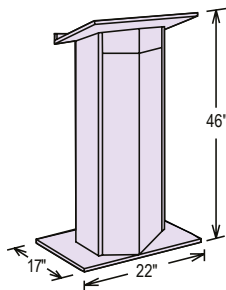
Optional Prefix	Description
M	Add Rechargeable Battery



Upgraded Amplifier with Flexible Gooseneck Microphone and Four Concealed Casters

Base Model	Description
800X-MY	Orator Lectern - Mahogany
800X-RW	Orator Lectern - Ribbonwood

Optional Suffix	Description
/LWM-5	Add Wireless Handheld Mic
/LWM-6	Add Wireless Tieclip Mic
/LWM-7	Add Wireless Headset Mic

Optional Prefix	Description
M	Add Rechargeable Battery

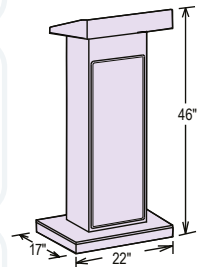



Base Model	Description
6010-MY	Aristocrat Floor Lectern - Mahogany

Optional Suffix	Description
/LWM-5	Add Wireless Handheld Mic
/LWM-6	Add Wireless Tieclip Mic
/LWM-7	Add Wireless Headset Mic

Optional Prefix	Description
M	Add Rechargeable Battery

Color



Mahogany
6010-MY

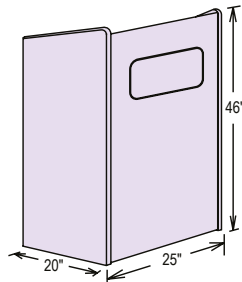

See Accessories

 Page 239

1-2 DAY
 LIGHTNING SHIP

ten year
 warranty
10

Veneer Lecterns

Combo Veneer Sound Lectern 950/901 Series



Upgraded Amplifier with Bluetooth/ USB Inputs Flexible
Goosneck Microphone and Four Concealed Casters

Base Model	Description
950/901-MY/WT	Combo Floor Sound Lectern - Mahogany on Walnut

Optional Suffix	Description
/LWM-5	Add Wireless Handheld Mic
/LWM-6	Add Wireless Tieclip Mic
/LWM-7	Add Wireless Headset Mic

Optional Prefix	Description
M	Add Rechargeable Battery

Color

Mahogany on Walnut
950/901-MY/WT

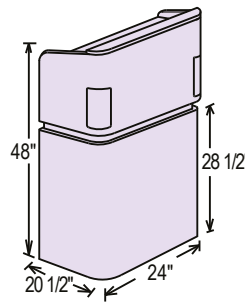

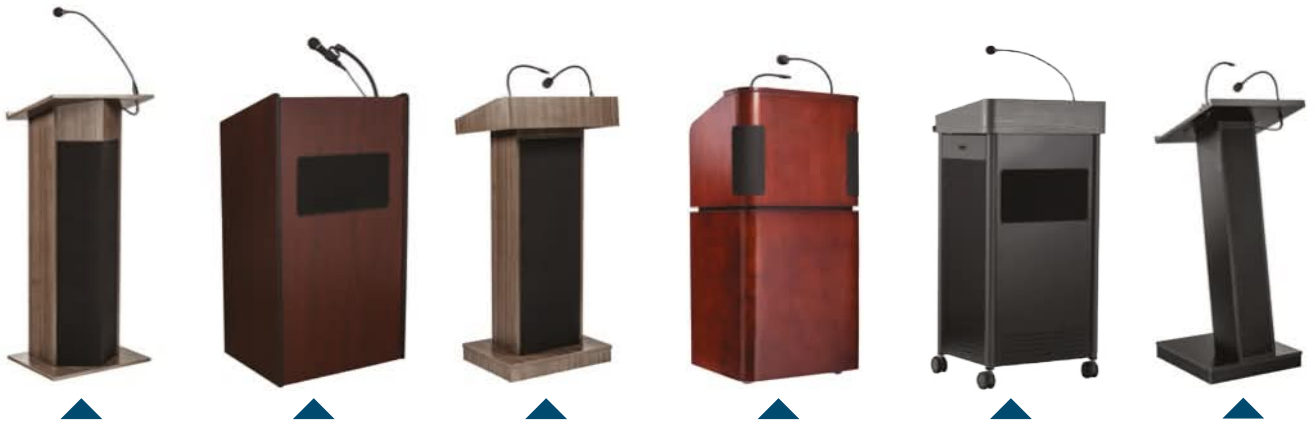

	111PLS	6010	800X	950 / 901	GSL-S	Zed
Dimensions	46"H X 22"W X 17"D	46"H X 25"W X 20"D	46"H X 22"W X 17"D	48"H X 24"W X 20"D	45.5" H X 23.5" W X 19.25" D	46.5" H X 19.5" W X 19.25" D
Weight	50 Lbs.	89 Lbs.	63 Lbs.	175 Lbs.	95 Lbs.	47.6 Lbs
Inside Shelf	20.5"W X 6"D	(2) 23.5"W X 18"D	12"W X 4"D	22"W X 16"D X 11"H	21"W X 14.75"D X 7"H	—
Microphones	1 Flexible Gooseneck Mic; One Tie-Clip/Lavalier Mic	2 Condenser Type: Handheld W/ 9' Cable; Tie-Clip Lavalier With 10' Cable	1 Flexible Gooseneck Mic; One Tie-Clip/Lavalier Mic	1 Flexible Gooseneck Mic; One Tie-Clip/Lavalier Mic	2 Condenser Type: 1 Flexible Gooseneck Mic; Tie-Clip Lavalier With 10' Cable	1 Flexible Gooseneck Mic; One Tie-Clip/Lavalier Mic
Speakers	Four 8" Full Range	Two 8" High Efficiency	Four 6" Full Range	Four 4" High Efficiency	Two 8" High Efficiency	Four 4" High Efficiency
Inputs	Two Mics, One Aux	Two Mics, One Aux	Two Mics, One Aux	Two Mics, One Aux	Two Mics, One Aux	Media Players, Extension Speakers, Usb, Bluetooth, Recording & Mp3
Wireless	Switchable; Two Frequency	Switchable; Two Frequency	Switchable; Two Frequency	Switchable; Two Frequency	Bluetooth Enabled	Bluetooth Enabled
Outputs	Line Out 1 – Extension Speaker Line Out 2 – Media Recorder	Line Out 1 – Extension Speaker Line Out 2 – Media Recorder	Line Out 1 – Extension Speaker Line Out 2 – Media Recorder	Line Out 1 – Extension Speaker Line Out 2 – Media Recorder	Line Out 1 – Extension Speaker Line Out 2 – Media Recorder	Line Out 1 – Extension Speaker Line Out 2 – Media Recorder
Controls	Four Volume, Bass/ Treble, On/Off	Four Volume, Bass/ Treble, On/Off	Four Volume, Bass/ Treble, On/Off	Four Volume, Bass/ Treble, On/Off, Bluetooth/Usb	Four Volume, Bass/ Treble, On/Off, Bluetooth/Usb	Four Volume, Bass/ Treble, On/Off, Bluetooth/Usb
Fuse	Internally Mounted, 2a	Internally Mounted, 2a	Internally Mounted, 2a	Internally Mounted, 2a	Internally Mounted, 2a	Internally Mounted, 2a
Power Supply	117 Volt Ac; 12 V Dc W/Optional Battery	117 Volt Ac; 12 V Dc W/Optional Battery	117 Volt Ac; 12 V Dc W/Optional Battery	117 Volt Ac; 12 V Dc W/Optional Battery	117 Volt Ac; 12 V Dc W/Optional Battery	117 Volt Ac; 12 V Dc W/Optional Battery
Recharger	Internally Mounted; W/Led Indicator	Internally Mounted; W/Led Indicator	Internally Mounted; W/Led Indicator	Internally Mounted; W/Led Indicator	Internally Mounted; W/Led Indicator	Internally Mounted; W/Led Indicator
Screen	—	—	—	—	—	—
Supported Formats	—	—	—	—	—	—

Available Accessories for Sound Lecterns



LWM-5
Wireless Handheld Mic



LWM-6
Wireless Tie-Clip/Lavalier Mic



LWM-7
Wireless Handheld Mic



PS12V
12V 5 Amp Rechargeable Battery

Model Number Configuration

Lectern Model Number Accessory Code

800XRW LWM-5

add "M" prefix to model number for rechargeable battery

PRESENTATION CARTS



**The Wizard Lectern
WZD Series**



Features



Surfaces Simultaneously Support: Doc Camera, LCD Projector, and Laptop



Attractive Cherry Wood Top & Base With Steel Cabinet



Sliding/ Locking LCD Projector Shelf



Storage Cabinet With Built in Power Strip

Product Feature WZD

Overall Dimensions	38"H x 25"W x 19"D
Boxed Dimensions	37"H x 25"W x 8"D
Surface Dimensions	25"W x 19"D
Laptop Shelf	16"W x 13"D
Side Shelves	16"W x 16"D
Drawer	15"W x 15"D x 2.5"H
Cabinet	23"H x 18"W x 16.5"D
Cabinet Shelf	18"W x 16.5"D
Weight	Unit 88 lbs / Boxed 99 lbs

Color



Wild Cherry on Black



**Multi Media Cart
MMC Series**



Features



Dual Flip up Shelves on Both Sides for Use of a Document Camera, Laptop and Projector Simultaneously



High Pressure Thermofused Scratch Resistance Laminate on Particle Board Core

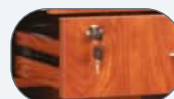

Locking Door and Drawer for Secure Storage

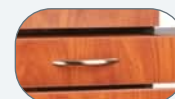

Front Slide-Out Laptop Shelf

Product Feature MMC

Top Surface	18" L x 21" W
Inside Dimensions	16" L x 14.5" W x 20"H
Projector Slide	16" L x 14" W
Built-In Drawer	10" L x 14" W x 5" H
Height	40" H
Side Pop-Up Shelf	14" L x 14" W

Color



Wild Cherry on Black

Premium Presentation Carts

Premium Presentation Cart
PRC200 Series



Premium Plus Presentation Cart
PRC250 Series



Features



Wire Management Grommets



6 Outlet Power Strip With 25' Cord With Winder



3" Casters (2 Locking)



Large Projector Shelf



Inner Shelf for Added Storage



Adjustable Height Laptop Shelf For Sitting Or Standing Position

Color



Ivory Woodgrain

Product Feature PRC200/PRC250

Dimensions	40.5"H x 18"W x 30"D
Top Shelf	18"W x 16.75"L
Laptop Shelf	18"W x 14"D
Middle Projector Shelf	16"W x 12"D
Bottom Shelf	18"W x 18"D
Weight	40 lbs
Carton size	37"L x 18"W x 5"H
Class	85
Color	Frame: Black; Shelves: Ivory wood grain
Steel	18 gauge
Paint	3 mil powder coating
Tops	Laminated on 3/4" MDF

PRC200

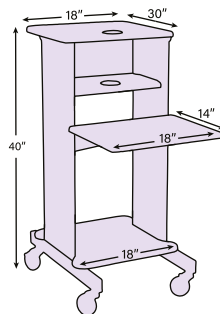

PRC250

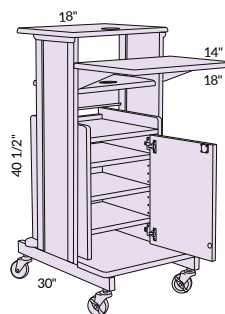

Premium Plus



Lockable Cabinet With 3 Adjustable / Removable Shelves



PRESENTATION CARTS | PRC400/PRC450 SERIES
Jumbo Presentation Carts

Jumbo Presentation Cart
 PRC400 Series

Jumbo Plus Presentation Cart
 PRC450 Series



Features



Spacious Lockable Cabinet With Adjustable Shelf



Adjustable Height Laptop Shelf for Sitting or Standing Position

Jumbo Plus



CPU Holder



6 Outlet Power Strip With 20-Foot Cord



Adjustable Height Side Shelf for Document Camera or Projector

Color



Ivory Woodgrain

Product Feature PRC400

Dimensions	40"H x 33"W x 21"D
Surface Dimensions	27"D x 21"W
Middle Projector Shelf	30.5"D x 17.5"W
Laptop Adjustable Shelf	21"W x 18"D
Locking Cabinet	25"D x 19"W x 24.75"H
Cabinet Adjustable Shelf	20"D x 19"W
Weight	100.5 lbs

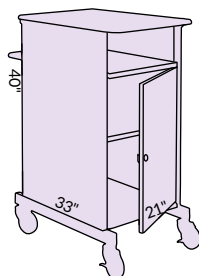

Product Feature PRC450

Dimensions	40"H x 33"W x 21"D
Surface Dimensions	27"D x 21"W
Middle Projector Shelf	30.5"D x 17.5"W
Laptop Adjustable Shelf	21"W x 18"D
Side Adjustable Shelf	24.5"W x 18"D
Locking Cabinet	25"D x 19"W x 24.75"H
Cabinet Adjustable Shelf	20"D x 19"W
Weight	117.5 lbs

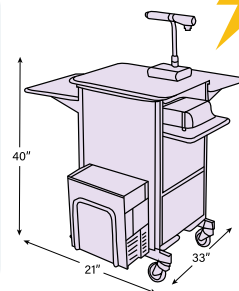

CHARGING CARTS

DUET CHARGING CART DCC Series



Model Number
DCC

Overall Dimensions: 28 1/8"W x 22"D x 38 1/4"H
Surface Dimensions: 22 3/4"W x 21 1/8"D
Shelf Dimensions: 22 1/4"W x 15 1/2"D



Features



18-Gauge Heavy-Duty Steel Parts



4 Heavy-Duty 4" Casters, 2 Locking



Fits 32 Laptops and Tablets With Screens up to 15.6" (up to 1" Thickness)



Adjustable Height Shelves Can Be Adjusted in 2" Increments



32 UL Approved Outlets on Built-in Power Strips



12ft Power Cord to Plug Into Wall



Maintenance Area With 4 Storage Shelves for Device Adapters



Dividers Can Be Positioned at Any Width in 1" Increments



Built in Wire Channels on Each Divider



2 Point Locking System on Front and Back Doors



Hook to Wrap the Power Cord on the Side of Cart



Grip-Rite Surface on Top of Cart

PRO AUDIO PA SYSTEM
PRA-8000 Series



1-2 DAY LIGHTNING SHIP

PA SYSTEM

Features



Sleek, Modern Design With Rounded Body



Transport Easily With Built-in Handle



USB Port for Mp3



Auxiliary Inputs for iPods and Other Media Players

Built-in underside receptacle for optional PRA-TRD Tripod set up

Microphone Options



PRA8-5
Wireless Handheld Mic



PRA8-6
Wireless Handheld Mic & Wireless Tie-Clip /Lavalier



PRA8-7
Wireless Handheld Mic & Wireless Mic Headset

Model Number

Prefix | Microphone Option
PRA8000/PRA8-5





BASICS

by NPS

Banquet Chairs & Stack Chairs

9100, 850-CL



Folding Chairs

900



Personal Table

PT3000



Stools

KD SERIES



 **NOW IN STOCK!**

NEW

The stool that does it all.



Build Your Perfect Stool

STANDARD



BACKREST



ADJUSTABLE HEIGHT



ADJUSTABLE HEIGHT & BACKREST



BASICS BY NPS | KD SERIES
Assembly-Ready Stools

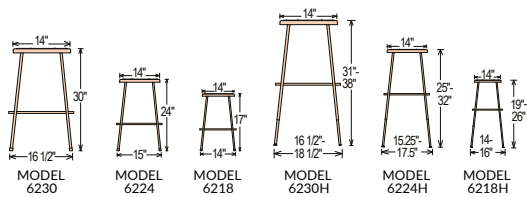

 **SHIPS ASSEMBLY-READY**
No Special Tools Required

Features



Modern Round
Masonite Seat



Heavy-Duty 18-Gauge
7/8" Steel Tubing



Industrial Grade
Glides



Ships Assembly-Ready,
No Special Tools or
Expertise Required



Add-on Backrest
Adjusts 2" Up/Down
and 2" Forward/Back



Add-on Chromed
Adjustable Height Inserts
Adjust to Nine Heights

Model #	Seat Height
6218-KD	17"
6224-KD	24"
6230-KD	30"
6218H-KD	19-26"
6224H-KD	25-32"
6230H-KD	31-38"

 **1-2 DAY**
LIGHTNING SHIP

Add-on Codes

Backrest	B
Adjustable Height	H
Adjustable Height and Backrest	HB



products meet
or exceed applicable
ANSI/BIFMA standards



Seat Color



Masonite

Frame Colors



Grey
(no code)



Black
(code: 10)

Model Number Configuration

Model Number Add-on Code (if applicable)

6218H-10-KD

Frame Color (if applicable)



Banquet Chairs



Vinyl Colors



9104-B
Midnight Blue



9108-B
Pleasant Burgundy

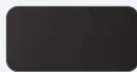

9110-B
Panther Black

Frame Color

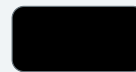

Black

on Page 214

Compatible with **DOLLY**

Dollies Category: DY-9000, DY81

Stack Up To **10** CHAIRS

Features



1" High Density
Grade-A Foam Seat



3/4" 19 Gauge
Square Tubing



Eight Plastic Stack
Bumpers for Secure
Stackability

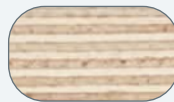

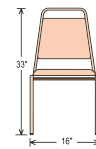

Plywood Core
Seat and Back





Stack Chairs



Colors

-  850-CL Black
-  855-CL Navy Blue

Features

-  Black Powdercoated Frame
-  18-Gauge, 1/2" Steel Tubing
-  Built-in Ganging Glides Link Multiple Chairs Together Easily
-  Polypropylene Seat & Back



Dollies Category
on Page 214
Compatible with **DOLLY**
DY-CL85
Stack Up To **30** CHAIRS

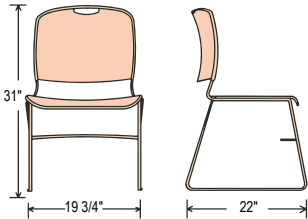

WEIGHT CAPACITY
300 lbs

1-2 DAY LIGHTNING SHIP

one year warranty
1

Folding Chairs

All-Steel 900 Series



Colors

-  901
Beige
-  902
Grey
-  910
Black

Vinyl Upholstered 950 Series





Colors

-  950
Black Vinyl
Black Frame
-  951
Beige Vinyl
Beige Frame
-  952
Grey Vinyl
Grey Frame

Fabric Upholstered 970 Series



Colors

-  970
Star Trail Black Fabric
Black Frame
-  973
Star Trail Brown Fabric
Beige Frame
-  974
Star Trail Blue Fabric
Navy Blue Frame

Features



Non-Marring
Glides



19-Gauge Steel
Frame



Single Hinge



Two Tack Welded
Leg Braces

on Page 214
Compatible
with **DOLLY**
DY-35, DY-50

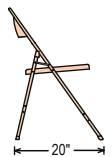
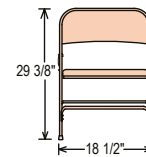

WEIGHT CAPACITY
250
lbs

1-2 DAY
LIGHTNING SHIP

one year
warranty
1



Dollies Category on Page 214
 Compatible with **DOLLY**
 42
 Holds **30** TABLES

1-2 DAY
 LIGHTNING SHIP

one year warranty
1

Features



1.67" Thick Tabletop

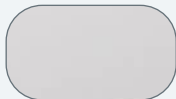

Speckled Grey Tabletop



20"x30" Tabletop



Powder Coated Textured Grey Frames and Legs



Plastic Clip to Hold Legs in Place



Glides Are Strong and Not Easily Removable



Adjustable Height Mechanism



Fully Welded Cross Brace

ADJUSTABLE TO SIX HEIGHTS

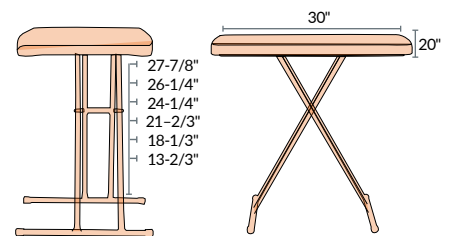

DESIGN OPTIONS Tabletop Guide



High Pressure Laminate

CORE MATERIAL	Industrial Grade Particleboard, MDF, or Plywood
FINISH	Matte Finish, Color Options Vary Per Product
EDGE	Vinyl T-Mold, 3MM PVC Edge Banding or Protect Edge
THICKNESS	Mobile Tables: 3/4" • Cafe Tables: 1-1/4" • Heavy-Duty Standard: 3/4" • Heavy-Duty Supreme: 1-1/4" • Science HPL: 1-1/8" • Mobile Flipper Tables 1-1/4"



Chem-Res

CORE MATERIAL	Industrial Grade Particleboard with Chemical Resistant High Pressure Laminate (HPL) on Top Side, Resin Backer Sheet on Bottom Side
FINISH	Black, Matte Finish
EDGE	3MM PVC Edge Banding bonded with heated adhesive
THICKNESS	1"



Phenolic

CORE MATERIAL	Solid Phenolic Resin
FINISH	Black, Matte Finish
EDGE	1/8" Bevel Edge
THICKNESS	3/4"



Epoxy

CORE MATERIAL	Solid Epoxy Resin
FINISH	Black, Matte Finish
EDGE	1/8" Bevel Edge
THICKNESS	1"



Trespa

CORE MATERIAL	Cellulose
FINISH	Black, Matte Finish
EDGE	1/8" Bevel Edge
THICKNESS	3/4"



Whiteboard

CORE MATERIAL	Industrial Grade Particleboard with High-Pressure Laminate (HPL) Top
FINISH	Whiteboard Surface
EDGE	3MM PVC Edge Banding
THICKNESS	1.25"



Butcherblock

CORE MATERIAL	Solid Hard Maple Edge Grain Top
FINISH	Proprietary Urethane-Based Satin Finish or Natural Penetrating Oil Finish. <i>See Page 181 for Details</i>
EDGE	Long Edge Beveled • Square Ends
THICKNESS	1.75"

MAINTENANCE INSTRUCTIONS: Clean butcher block surfaces with soapy water or common kitchen counter top cleaners. Do not use abrasives or powder cleansers. Do not allow moisture to stand on the surface for prolonged periods of time.

Butcherblock Finishing Options & Stainless Steel Tops Sepcs

Stainless Steel Tabletop Edge Styles

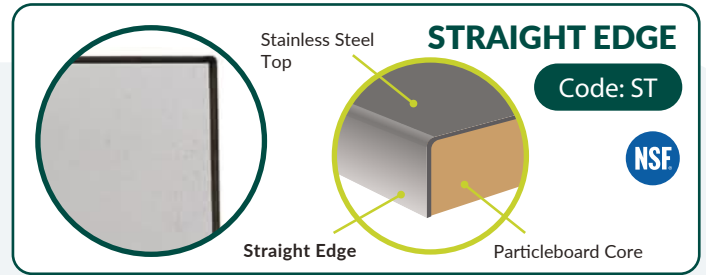
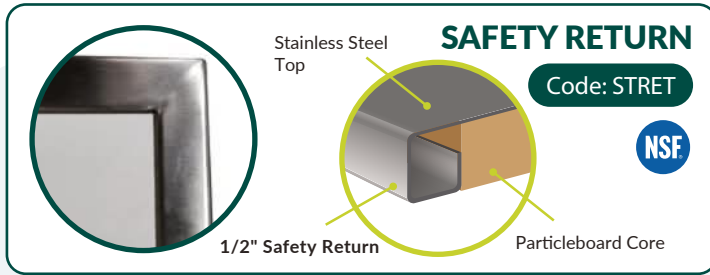

SURFACE SPECIFICATIONS

- Heavy-Duty 16GA Thickness
- Grade 304: High Nickel Content Type 300 Stainless Steel, #4 Polish
- 1/4" Radius on All Top Edges & Vertical Corners
- 1-3/8" Thick Particle Board Underlayment with Melamine Backing

MAINTENANCE

CLEANING INSTRUCTIONS

Use the proper tools, clean water, and non-chloride cleaning solutions to clean dirty stainless steel surfaces. Avoid letting liquids, food particles, dirt, or any other debris sit on the stainless steel for extended periods. Refrain from using chlorine bleach, but if it is used, rinse thoroughly with water right away and dry the surface with a soft, clean towel. Always clean and wipe along the direction of the stainless steel's polish lines.

RESTORING & POLISHING YOUR STAINLESS STEEL TABLETOP

It is recommended to use a stainless steel cleaner specifically designed to polish and restore stainless steel surfaces. Choose a natural, food-safe formula that is suitable for all stainless steel surfaces used in food preparation.

Always clean and wipe in the direction of the polish lines to maintain its smooth finish and prevent scratches.



WARNING

Stainless steel resists corrosion due to a thin, invisible film created by its 12%-30% chromium content. However, if this film is damaged or scratched, the steel can corrode. Factors like chlorides in cleaners, water, food particles, and salt can weaken the film. Proper maintenance and cleaning are essential to preserve the film and ensure the equipment's durability.



Butcherblock Finishing Options

STANDARD



Urethane-Based Satin Finish

Code: BB

CORE MATERIAL	Solid Hard Maple Edge Grain Top
FINISH	Proprietary Urethane-Based Satin Finish
EDGE	Long Edge Beveled • Square Ends
THICKNESS	1.75"
FOOD SAFE	Yes

MAINTENANCE Recommended to re-finish every 2-3 weeks depending on usage.



Refinishing can be done fairly quickly using a rag and **Emmet's Good Stuff Gel Urethane**

CUSTOM

Upcharge and Extended Lead Time apply



Varnique Semi-Gloss Finish

Code: BV

CORE MATERIAL	Solid Hard Maple Edge Grain Top
FINISH	Natural Penetrating Oil Finish
EDGE	Long Edge Beveled • Square Ends
THICKNESS	1.75"
FOOD SAFE	Yes

MAINTENANCE Recommended to re-finish every 3-4 weeks depending on usage.



Refinishing can be done fairly quickly using a rag and **Boos® EZ-DO Finish**

Limited Warranty: Since Natural Wood Products rely heavily on the care they receive, Butcherblock Tabletops have One Year Warranty. The rest of the parts of the product still carry a Ten Year Warranty.

DESIGN OPTIONS

Edge and Stool

Standard Edges No minimum required



Vinyl T-Molding | Black (TM)



Protect Edge | Black (PE)



3MM PVC Edge Banding | Black (EB)

Premium Edges May be subject to minimum quantity and upcharge



Grey (PA)



Blue (PU)



Green (PV)



Burgundy (PH)



Tangerine (PT)



Yellow (PW)



Purple (PJ)



Red (PZ)



Pacific Blue (PF)



Pea Pod (PK)



Grey (EA)



Blue (EU)



Green (EV)



Burgundy (EH)



Tangerine (ET)



Yellow (EW)



Purple (EJ)



Red (EZ)



Pacific Blue (EF)



Pea Pod (EK)

PROTECT EDGE

3MM PVC EDGE BANDING

Stool Top Color Options



Black (10)



Grey (02)



Blue (04)



Green (06)



Burgundy (08)



Tangerine (17)



Yellow (25)



Purple (28)



Red (40)



Pacific Blue (14)



Pea Pod (16)

TWO STOOL SHAPES AVAILABLE



Round Stool



ErgoMax Stool



In Demand Laminate Collection No minimum required



Our In Demand Collection features a curated selection of laminate colors available from both Wilsonart and Formica, offering close matches across brands. Choosing from this collection helps streamline the manufacturing process, requires no minimum order, and ensures a more robust, reliable supply chain for your laminate selection.



Quick Ship Laminates

1 WEEK Select Sizes



High Pressure Laminate Collection

All laminates are STANDARD with no minimum required unless you see these labels: Minimum Quantity, upcharge and longer lead time apply for PREMIUM laminates.

Premium Wilsonart Premium **Premium** Formica Premium

W Wilsonart Standard **F** Formica Standard **WI** Wilsonart In Demand **FI** Formica In Demand

SOLID COLORS



DESIGN OPTIONS

High Pressure Laminates

LABELS: **W** Wilsonart Standard **F** Formica Standard **WI** Wilsonart In Demand **FI** Formica In Demand

Premium Wilsonart Premium **Premium** Formica Premium

SOLID COLORS

W Shadow OW	F Earth YE	FI Dark Chocolate DK	WI Coffee Bean CB	FI Black BK	FI Graphite GI	WI Slate Grey SG	Premium Charcoal Velvet CV	W Charcoal OL	W Graphite GP
F Storm RD	WI North Sea NS	W Fossil Shale FA	WI Dove Grey DG	FI Platinum QL	W Fashion Grey GF	F Oyster Gray OY	W Grey RG	FI Mouse OU	W Pewter PE
F Gull Grey GU	F Fog FG	W Cement EJ	W Platinum PL	F Zen Grey ZN	F Folkstone VF	F Green Slate GS	W Hunter Green GR	F Spectrum Green QG	F Vibrant Green VN
W Island IS	F Jadeite JA	W Ocean OC	F Matrix Blue MX	FI Spectrum Blue SB	W Lapis Blue LB	WI Persian Blue BL	F Marine Blue ME	FI Navy Blue NB	WI Indigo IN
W Atlantis AT	F Denim DN	W Brittany Blue BB	F Winter Sky SY	F Fossil FZ	F Liquid Glass LQ	F Glass Cloth GL	WI Linen LI	F Chrome Yellow YL	Premium Bakelite Gold GD
F Golden Braze GB	F Blush BQ	F Earthenware EQ	W Orange Grove OG	F Clementine CQ	F Spectrum Red SR	F Stop Red RD	W Hollyberry RE	W Regimental Red RR	W Port PO
F New Burgundy BU	F Cassis XS	F Purple Dye PY							

WOODGRAINS

Premium White Barn HI	Premium White Cypress CY	F Birchbark RK	F White Washed Birchply WY	W Asian Sand AS	F Pale Brushstroke QB	W Ivory Birch IY	Premium Phantom Ecru EC	F Ashwood Bone AH	Premium Italian Silver Ash IA
WI Beigewood BW	WI Manitoba Maple MT	WI Limber Maple LM	W Fusion Maple FM	FI Sand Maple ZM	W Natural Maple NM	FI Hard Rock Maple HQ	W Mission Maple MI	F Natural Ash NH	Premium Blond Echo BO
F Planked Raw Oak PD	F Cream Softwood CJ	F Danish Maple DA	F Swede Rift Oak WE	Premium Ruskin Oak RU	W Natural Rift RF	FI Wood Brushstroke WQ	W New Age Oak NW	F Cherry Walnut YC	F Pecan Woodline PC

WOODGRAINS

W Castle Oak CO	W Bannister Oak OK	W Monticello Maple MP	F Natural Birch NQ	F Finnish Oak FK	W Solar Oak SO	W Harvest Maple HM	F Scandi Rift Oak RO	W Fonthill Pear FP	W Brazilwood BI
W Sap Walnut XW	Premium Fawn Cypress FC	F Millennium Oak MK	Premium Fawn Walnut XF	Premium Louisiana Pecan LP	W Pasadena Oak PK	W Natural Recon NR	W Golden Oak GO	F Natural Oak NK	W Nepal Teak NT
W Huntington Maple HN	W Wild Cherry CH	F Earthenware Brushstroke EB	F Wild Cherry WI	F Pecan Walnut QW	F Planked Urban Oak PU	W River Cherry RC	F Camel Elm CM	W NeoWalnut NO	F Hazel Walnut HW
W Palisades Oak OA	Premium Loft Oak LF	Premium Uptown Walnut UW	Premium Landmark Wood LW	W Buka Bark KB	Premium Veranda Teak VT	WI Premium Studio Teak TK	F Silver Riftwood SI	W Pinnacle Walnut PN	F Planked Coffee Oak ZP
W Mangalore Mango MO	Premium Phantom Cocoa OM	FI Gallery Teak GK	W Montana Walnut WT	Premium Brun Refined Hickory RH	Premium English Oak EO	W Lowell Ash LA	Premium Shaker Cherry SC	W Bourbon Cherry BX	Premium Biltmore Cherry BC
Premium Rio XR	W Windsor Mahogany WM	Premium Williamsburg Cherry WC	F Acajou Mahogany AC	F Cocoa Maple QM	Premium Empire Mahogany EM	W Figured Mahogany MY	W Colombian Walnut CW	F Chestnut Woodline OO	F Black Walnut KX
F Walnut Butcherblock FB	F Formal Walnut FQ	F Sorrel Cherry EL	W Asian Night AN	F Walnut Riftwood WR	W Florence Walnut FO	W Gunstock Walnut GW	W Morelia Mango MM	F Cascara Teakwood CC	F Antique Mango AM
Premium Skyline Walnut SW	F Wenge Strand EN	F Clover Spice Cherry CX	W Ebony Recon ER	Premium Xanadu XD	F Prestige Walnut PQ	F Blackened Legno LE	F Graphite Elm EG	F Blackened Steel BS	F Black Riftwood BR
Premium Mineral Walnut MW	F Smoky Brown Pear KY	Premium Storm Teakwood XK	W Sterling Ash SA	Premium Portico Teak PT	Premium Beach Birch BH	W Boardwalk Oak BD	Premium Monteverdi MV	Premium Phantom Charcoal PX	F Weathered Ash ED
Premium Valley Forge Elm VA	F Bleached Legno LG	W French Pear FR	F Taupe Walnut TY	F Buff Elm BM	W High Line HL	W Kingswood Walnut KT	F Grayed Oak YK	W Cenizo Cherry XC	Premium Silver Alchemy SV
F Fox Teakwood FX	F Weathered Fiberwood EF	Premium Silver Oak Ply SK	Premium White Driftwood WD	Premium Grey Elm GE					

DESIGN OPTIONS

High Pressure Laminates

LABELS: **W** Wilsonart Standard **F** Formica Standard **WI** Wilsonart In Demand **FI** Formica In Demand

Premium Wilsonart Premium **Premium** Formica Premium

FIBERS/TEXTILES

Premium Magnolia MG	Premium Pale Brass XP	Premium Wheat Berry BY	W Sunny Side Up UP	Premium Quince QN	Premium Marmalade ML	W Dragon Fire DF	W Candy Apple CD	W Robin RN	W Concord Grape CG
Premium Iolite IO	W Gumball GM	W Mushroom MU	W Battleship SH	W Blackbird CK	W Nightfall NF	Premium Blueberry Tart BJ	Premium Blue Curacao CR	W Catalina CI	Premium Bellini Blue XB
W Cornflower FF	Premium Waterspout WU	Premium Green Tourmaline TO	W Nori NI	Premium Kale Leaf KL	Premium Dublin Crossweave DU	W Fresh Cut FE	F Green Felt LT	F Orange Felt OF	F Yellow Felt YT
F Natural Gray Felt FT	W Handspun Slate HE	W Handspun Chestnut HS	W Handspun Dove HD	W Handspun Pearl DP	F Muslin Fabric MF	F Sheer Fabric SQ	F Gray Fabric QF	F Chambray Fabric ZF	W French Linen FN
W Tailored Linen UP	W Nordic Linen ND	W Pressed Linen LN	W Casual Linen CU	W Flax Linen FL	W Classic Linen LL	W Crisp Linen CL	F Cotton Cloth TT	W Organic Cotton OT	W Raw Cotton RW
W Natural Cotton NU	F Woolen Cloth WK	W Almond Leather AL	W Burnished Chestnut CT	F Earthen Warp EW	F Citadel Warp RP	W Carbon Mesh CA	W Steel Mesh SL	W Pewter Mesh PW	W Grey Mesh GH
W Sheer Mesh SM									

STONES

F Black Shalestone BN	W Oiled Soapstone OS	Premium Andora Shadow AW	Premium Ink Vesta IV	W Desert Springs DE	F Flint Crystal FI	F Folkstone Celesta YF	W Dusk Cascade DD	W Pearl Soapstone PS	F Patine Concrete QO
F Argento Romano RM	F Bubble Art UB	F Sea Salt ZS	F Neo Cloud UD	F Carrara Bianco ZC	W Ice Mist IC	Premium Calacatta Lincoln LC	W White Cascade TC	W Pebble Piazza ZZ	F Patine Chalk QC
W Mystique Moonlight MQ	W Tumbled Roca TU	W Kalahari Topaz KZ	W Tan Soapstone TS	W Mystique Dawn MD					

PARTICLES

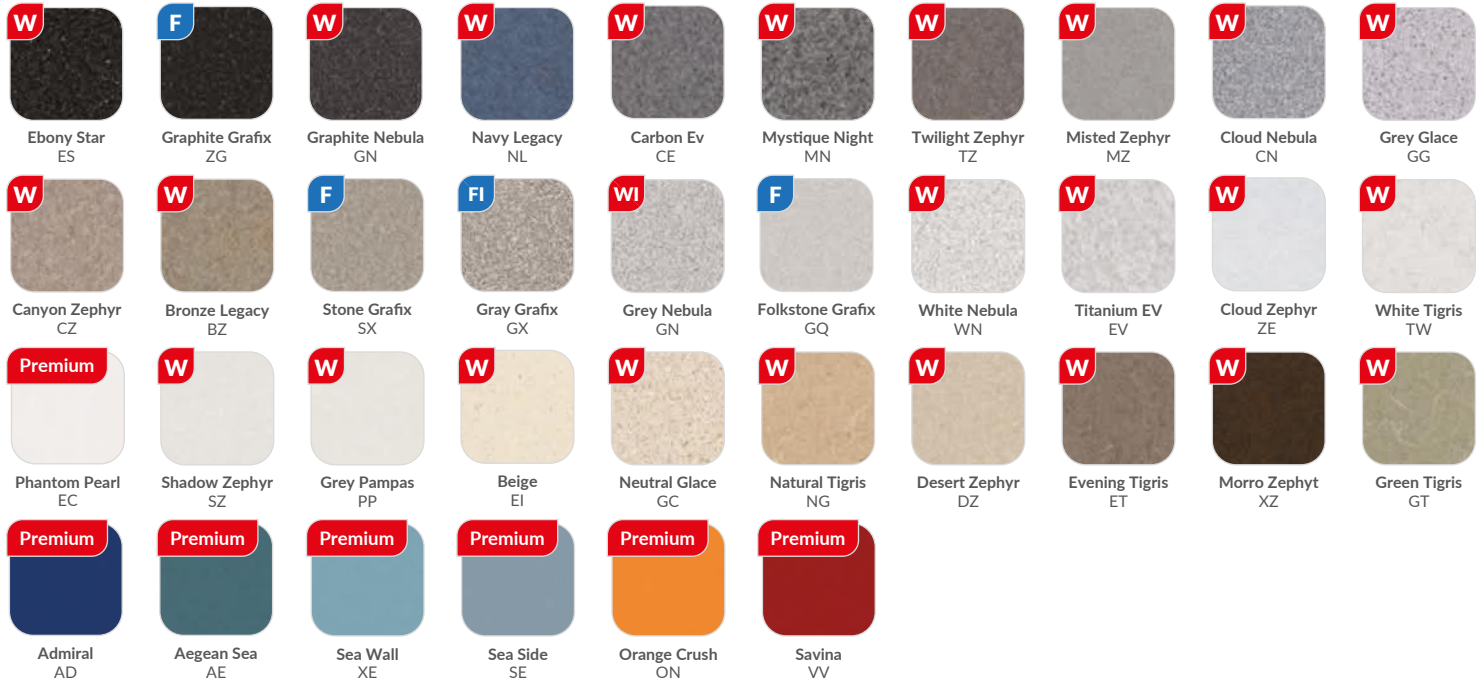

METAL

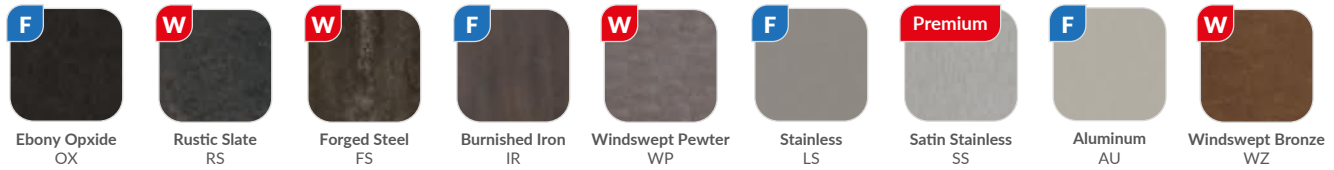

ABSTRACT/GRAPHICAL



Choose any laminates from:

May be subject to minimum quantity and upcharge



**IF YOU DON'T
 SEE A LAMINATE,
 JUST ASK!**

ELEVATE ANY SPACE WITH PERSONALIZED DESIGNS!

Upcharge and extended lead times apply

Customize Your Surface with a Laminate Design Inspired by YOUR LOGO



JUST SEND US A LOGO FILE
(or any image of your Logo)



BULLDOGS

Streamline Your Space: Elegant Power Solutions for Ultimate Efficiency!

For all HPL Tables

Basic Grommet Cover PPDT10-GROM



- 3.5" Diameter
- Color Black

Wireless Charging Grommet PPDT10-W



- Round Grommet Power Dock
- 8' Cord
- 3" Diameter
- Qi Wireless Charger
- Color Black

Dual AC Power Grommet PPDT10-2



- 3" Diameter
- Color Black
- 2 AC Outlets
- 10' Cord

AC + USB Combo Grommet PPDT10-2



- 3" Diameter
- Color Black
- 2 AC Outlets
- 10' Cord

Pull-Up AC + USB Grommet PPDT10-3P-AC



- 3" Diameter
- 1 USB Type-C Port
- 2 AC Receptacles
- Color Black
- 1 USB Type-A
- 6' Cord

Pull-Up Triple AC Grommet PPDT10-3P



- 3" Diameter
- Color Black
- 3 AC Receptacles
- 6' Cord

All of these products are



Note: To order, please send a placement file to NPS, and we will make the hole in the appropriate location for simple installation upon receipt of your table. Please allow for a 2" tolerance in the placement.

MSC Series Custom Colors & Custom Phenolics

TFL Custom Color Options

Upcharge and extended lead time apply. Custom colors not available for MSC2436.



Winter Fun
W3



White Chocolate
W2



First Dance
F1



Brushed Aluminum
B3



Love At First Sight
L2



Crème De La Crème
C1



River Rock
R1



Mastermind
M1



Sheer Beauty
S1



Apres Ski
A1



Stargazer
S3



Rustik Cherry
R2



Sunday Brunch
S7



Shiraz Cherry
S2



Moonlight
M2



Black Woodgrain
B2



Latitude West
L1



Black
B1



Model Number Configuration

Model Number

Mirror/Whiteboard (if applicable)

MSC01 P WS - XX

TFL Color

Phenolic Tabletop (if applicable) Sink (if applicable)

Black Core Phenolic

MOQ, upcharge and extended lead time apply



PFG705

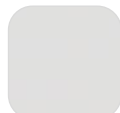

PFS729



PBW954



PMO829



PAL029



PFO9435



PLG0428



PGS3978



PSR938



PNB6697



PSO5328



PEA2435



PPU858



PMJ1578



PNB969

Color Thru Phenolic

MOQ, upcharge and extended lead time apply



PNB969CT



PMO829CT



PMJ1578CT

DESIGN OPTIONS

Custom 9200/9300 Series Banquet Chairs

MOQ, upcharge and extended lead time apply

Fabrics



Midnight Blue
54



Ebony Black
60



Natural Chocolatier
61



Natural Greystone
62



Diamond Navy
64



Natural Blue
74



Natural Taupe
78



Auburn
F201



Brown
F202

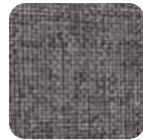

Charcoal
F203



Cobalt
F204



Black Patterned
F205



Fossil
F206



Golden Burgundy
F207



Grape
F208



Brown Dot
F209



Grey Dot
F210



Hunter Green
F211



Indigo
F212



Mixed Tan
F214



Pink Grape
F215



Purple
F216



Red Rose
F217



Walnut
F218



Diamond Burgundy
F219



Graphite
F220

Vinyls



French Beige
01



Midnight Blue
04



Pleasant Burgundy
08



Panther Black
10



Black
V101



Dark Brown
V102



Cobalt Blue
V103



Tan
V104



Burgundy
V105



Medium Brown
V106



Textured Black
V107

Model # Description

93	9300 Series Silhouette Stack Chair
92	9200 Series Dome Stack Chair

Frames



Black Sandtex
BT



Silver Vein
SV



Mocha
M

Model Number Configuration



Custom Color Options

300 Chair MOQ and Extended Lead Times Apply

Frame Colors



Available for 8700/8800

Poly



Available for 8700

Vinyl

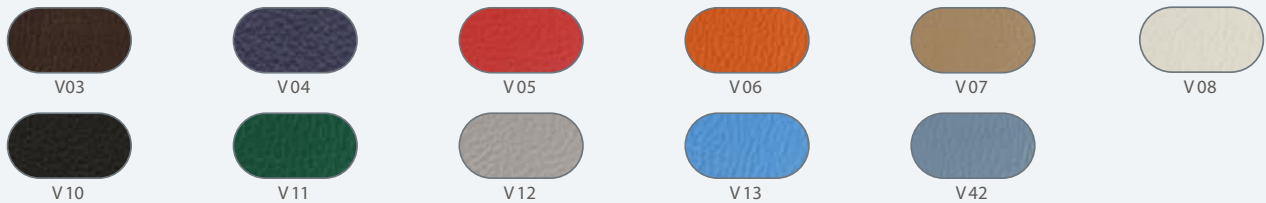

Available for 8700

Fabric



8700/8800 Custom Configuration

Model Number Frame Color
87* PXX-XX-PXX
 Seat Color Back Color

*Add B for Bar Height or C for Counter Height

DESIGN OPTIONS

Activity Table Shapes

For HDTA | SLTA | ALT10A Series

Shapes

Arc 1

CODE: AR1

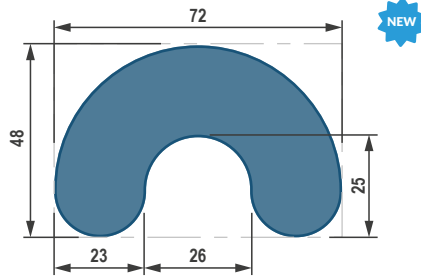

Sizes: (Width/Length in Inches)

4872

Arc 2

CODE: AR2

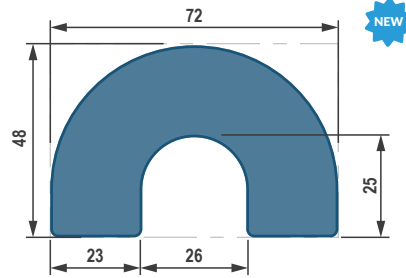

Sizes: (Width/Length in Inches)

4872

Horseshoe 1

CODE: HS1

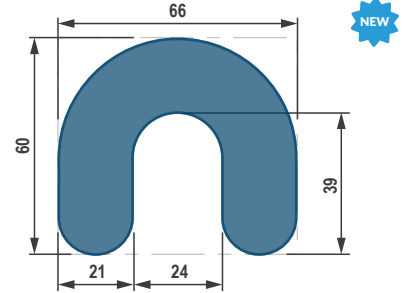

Sizes: (Width/Length in Inches)

6066

Horseshoe 2

CODE: HS2

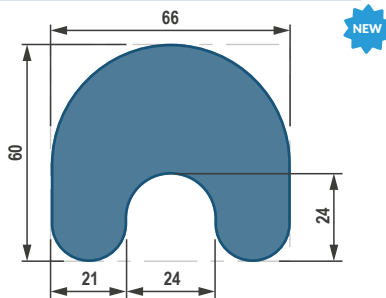

Sizes: (Width/Length in Inches)

6066

Horseshoe 3

CODE: HS3

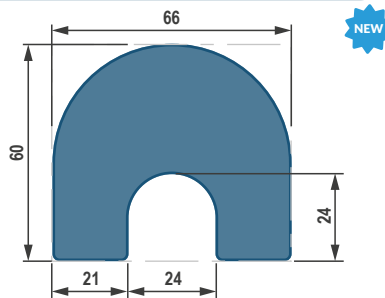

Sizes: (Width/Length in Inches)

6066

Horseshoe 4

CODE: HS4

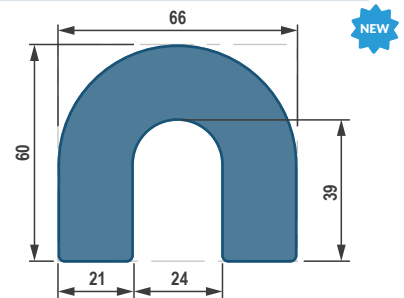

Sizes: (Width/Length in Inches)

6066

Flower Tri

CODE: FT

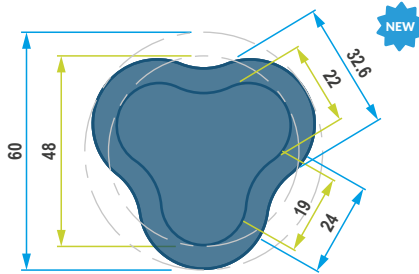

Sizes: (Width in Inches)

48 60

Flower Quad

CODE: FQ

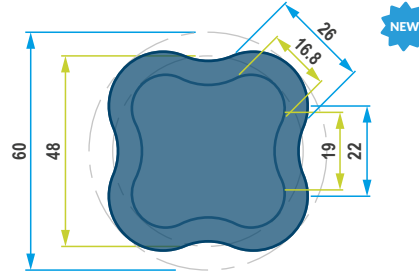

Sizes: (Width in Inches)

48 60

Kidney 1

CODE: KI1

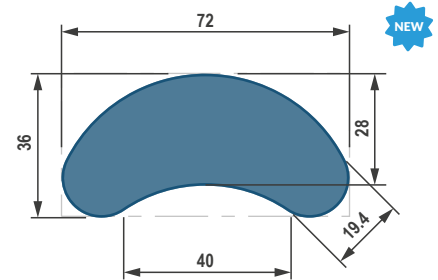

Sizes: (Width/Length in Inches)

3672

Kidney 2

CODE: KI2

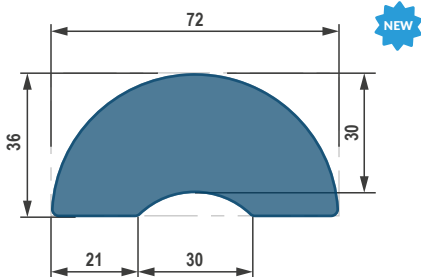

Sizes: (Width/Length in Inches)

3672

Kidney 3

CODE: KI3

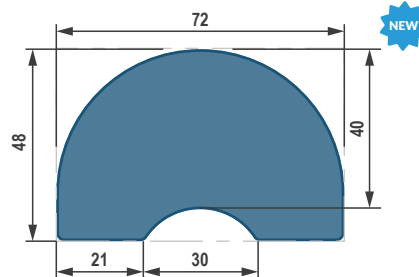

Sizes: (Width/Length in Inches)

4872

Kidney 4

CODE: KI4

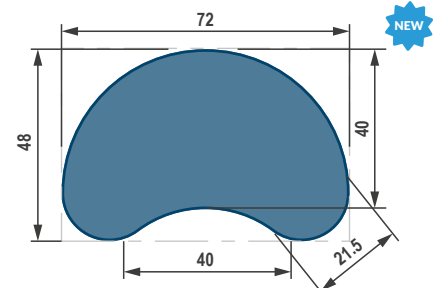

Sizes: (Width/Length in Inches)

4872

Shapes

Clover Tri 1

CODE: CT1

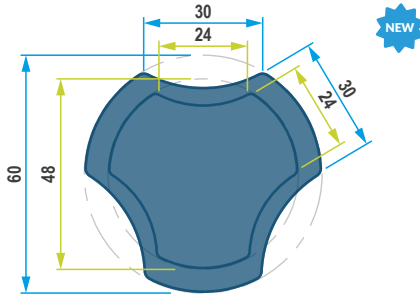

NEW

Sizes: (Width in Inches)

48 60

Clover Tri 2

CODE: CT2

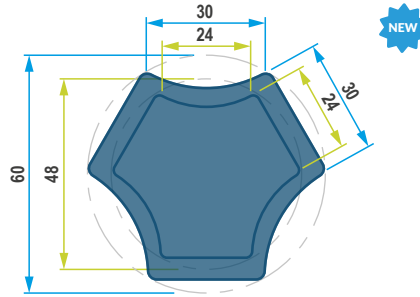

NEW

Sizes: (Width in Inches)

48 60

Clover Quad 1

CODE: CQ1

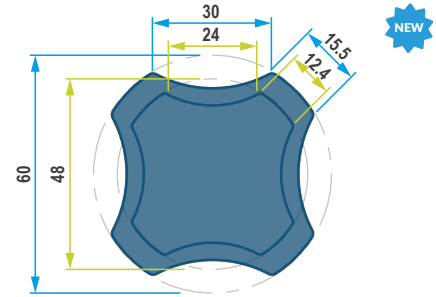

NEW

Sizes: (Width in Inches)

48 60

Clover Quad 2

CODE: CQ2

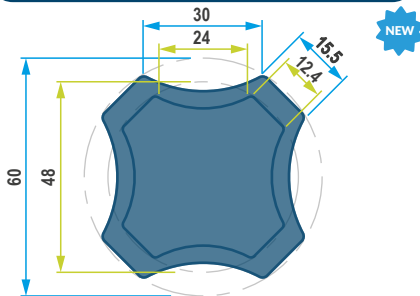

NEW

Sizes: (Width in Inches)

48 60

Pointed

CODE: PT

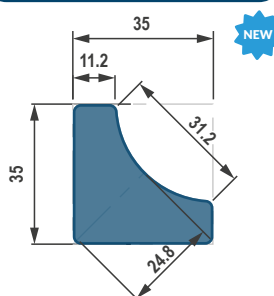

NEW

Sizes: (Width/Length in Inches)

3535

Hourglass

CODE: HG

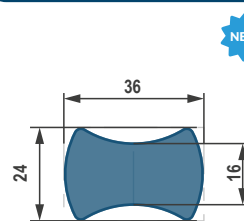

NEW

Sizes: (Width/Length in Inches)

2436

Crescent

CODE: CR

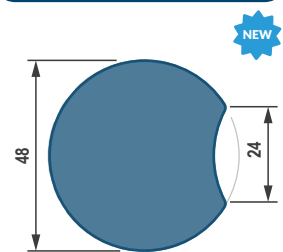

NEW

Sizes: (Diameter in Inches)

48

Trapezoid

CODE: TZ

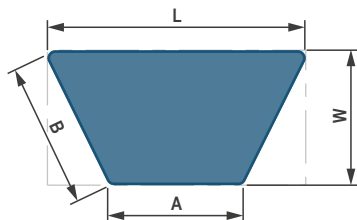

Sizes: (In Inches)

Size Code	W	L	A	B
2448	24	48	31	25
2454	24	54	37	25
2460	24	60	43	25
2472	24	72	55	25
3054	30	54	33	32
3060	30	60	38	32
3072	30	72	50	32

Tri

CODE: TR

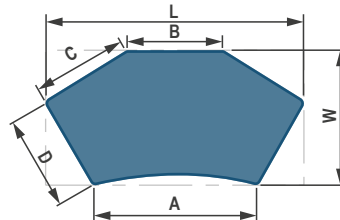

Sizes: (In Inches)

Size Code	W	L	A	B	C	D
2454	24	54	35	24	18	18
2460	24	60	47	24	21	16
3054	30	54	35	24	18	25
3060	30	60	40	24	21	23

Hexa

CODE: HX

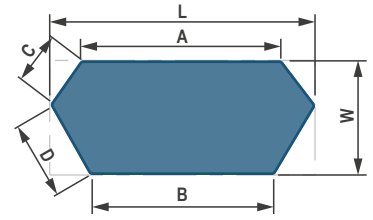

Sizes: (In Inches)

Size Code	W	L	A	B	C	D
2454	24	54	42	39	13	18
2460	24	60	49	45	13	18
2472	24	72	57	54	13	18
3060	30	60	42	36	18	20
3072	30	72	54	48	18	20

Round

CODE: RD

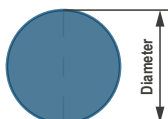

Sizes: (Diameter in Inches)

36 42 48 60

Semicircle

CODE: SC

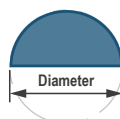

Sizes: (Diameter of Full Circle in Inches)

48 60

Rectangle

Student Desk Size

CODE: RC



Sizes: (Width/Length in Inches)

2028 2230 2436

Square

CODE: SQ



Sizes: (Width in Inches)

24 30 36 42 48

Protecting the environment is one of the most important factors affecting the future of the planet. Most people are now aware of the necessity of preserving and protecting nature in order to ensure our well-being and that of our children. Pollution, especially that related to the over-consumption of raw materials, has reached alarming levels due to our current lifestyle. That is why at National Public Seating® we are constantly striving to minimize the consequences of our activities.

At National Public Seating®, the quality of our products and the protection of the environment go hand in hand. As a consumer of raw material, we are committed to the use of pre and post consumer waste (recycled material), while preserving the high quality standards of our products.

ENVIRONMENTAL STATEMENT

EXAMPLES OF THIS INCLUDE:

- **STEEL** - All of the steel for our products contain 30-40% of post-consumer waste (recycled).
- **CORRUGATED CONTAINERS** - Are made of recycled fiber. 100% total recycled content and 90% post consumer content minimum.
- **PLASTIC** - Our plastic products contain up to 35% of pre-consumer waste.
- **WOOD** - 100% of wood used for our products comes from non-boreal forests.
- **POWDER COATING VS. LIQUID FINISHES** - Our products are powder coated and are highly protective to our environment. While liquid finishes contain solvents which have pollutants known as volatile organic compounds (VOCs), powder coating contains no solvents and releases negligible amounts, if any, of VOCs into the atmosphere. In addition, most powder coating overspray that does not adhere to the part is retrieved and reused, virtually eliminating the waste commonly found in liquid finishing processes.
- **ENERGY** - During November 2008, National Public Seating®, completed a retrofit of all its lighting (over 800 fixtures), to eco-friendly units, saving 135,586 kWh annually. This reduction in energy consumption has an environmental impact equivalent to removing 20 cars from the road, 84 tons of greenhouse gas (CO2) and saving 198 barrels of oil annually!
- **AIR EMISSIONS** - Our Folding Chairs are manufactured within ANSI BIFMA X7.1 2007 VOC Air Emission guidelines; Criteria #1 - TVOC, Formaldehyde, All Aldehydes & 4-Phenylcyclohexene.
- **MAS CERTIFIED GREEN** - The entire NPS® Product Line is now MAS Certified Green™, a nationally recognized registered trademark delineating low VOC emitting products in the marketplace so that purchasers and specifiers of those products know that they can earn credits in sustainability programs like LEED, BIFMA's Level, and California CHP program.
- **SOLAR ENERGY** - As the industry leader in institutional-grade furniture, including portable folding furniture for lunch rooms, training rooms, etc., & furniture for worship halls, science labs, music programs, performing arts, cafeterias & others, NPS® continues to trailblaze in setting the standard for environmental stewardship. In addition to minimizing its eco footprint in the areas of raw material sourcing, energy consumption & air emissions, NPS® is proud to announce a major solar panel installation on the roof of its 200,000 square foot factory facility in its corporate headquarters in Clifton, NJ, completed Summer 2011. Via the installation of a 240KW solar PV system on its roof, we will offset most of the local utility's need to burn oil and gas for electrical production in the public grid and therefore reduce greenhouse gas emissions into the atmosphere. Since we will be generating 80% of the electricity that we use with this system, we have cut our carbon footprint significantly.



WARRANTY INFORMATION

National Public Seating® offers the original user a warranty against all manufacturing defects in material and workmanship from date of purchase for ten years*. If defective, NPS will, at its option, repair or replace the defective product. This warranty does not apply to damage resulting from misuse, abuse or neglect. Excessive swaying back and forth on any banquet stack chair will entirely void the warranty. Authorization for return and / or repairs is required by contacting your dealer. This warranty gives you specific rights, and you may also have other rights which vary by state.

Orders are accepted under the express agreement that under no circumstances will seller be liable for any incidental or consequential damages, or for any other loss,

damage or expense of any kind, including loss of profits, arising in connection with the order or with the use or inability to use seller's products furnished under the order. Seller's maximum liability shall not exceed and buyer's remedy is limited to either (i) repair or replacement of the defective part or product, or at seller's option (ii) return of the product and refund of the purchase price. Such remedy shall be the buyer's entire and exclusive remedy.

*Fifteen years for Mobile Cafeteria Tables,

*Five years for Oklahoma Sound®,

*One year for Basics By NPS and Butcherblock



GENERAL PRODUCTS



MOBILE TABLES



OKLAHOMA SOUND®



BASICS BY NPS



ADDRESS 149 Entin Road | Clifton, New Jersey 07014

TEL 800.261.4112 | FAX 973.594.9339

www.nationalpublicseating.com



SOLD THRU:

**National
Public
Seating**



149 Entin Road | Clifton, NJ 07014
Tel 800.261.4112 | Fax 973.594.9339
www.nationalpublicseating.com